

半導体物性工学基礎

阿部 英介

慶應義塾大学スピントロニクス研究センター

応用物理情報特別講義A

2018年度春学期後半 金曜4限@14-202

半導体

周期表

II (12)	III (13)	IV (14)	V (15)	VI (16)
	B	C	N	O
	Al	Si	P	S
Zn	Ga	Ge	As	Se
Cd	In	Sn	Sb	Te
Hg	Tl	Pb	Bi	Po

典型的な半導体の例

IV族: Diamond, Si, Ge, SiGe...

III-V族: GaN, GaAs, InAs, InSb...

II-VI族: ZnO, ZnSe, HgTe...

バンド構造

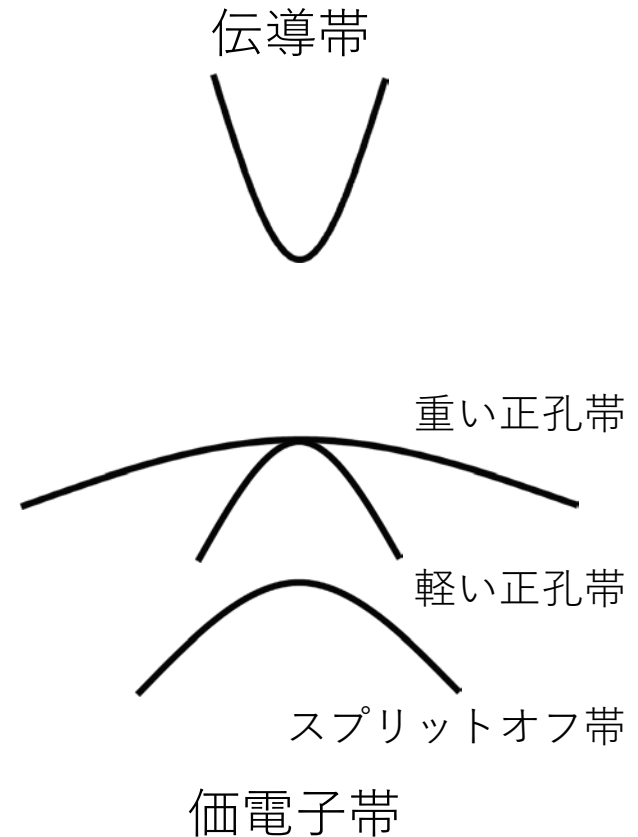

バンドギャップ

III (13)	IV (14)	V (15)
Al	Si	P
Ga	Ge	As
In	Sn	Sb

閃亜鉛鉱構造

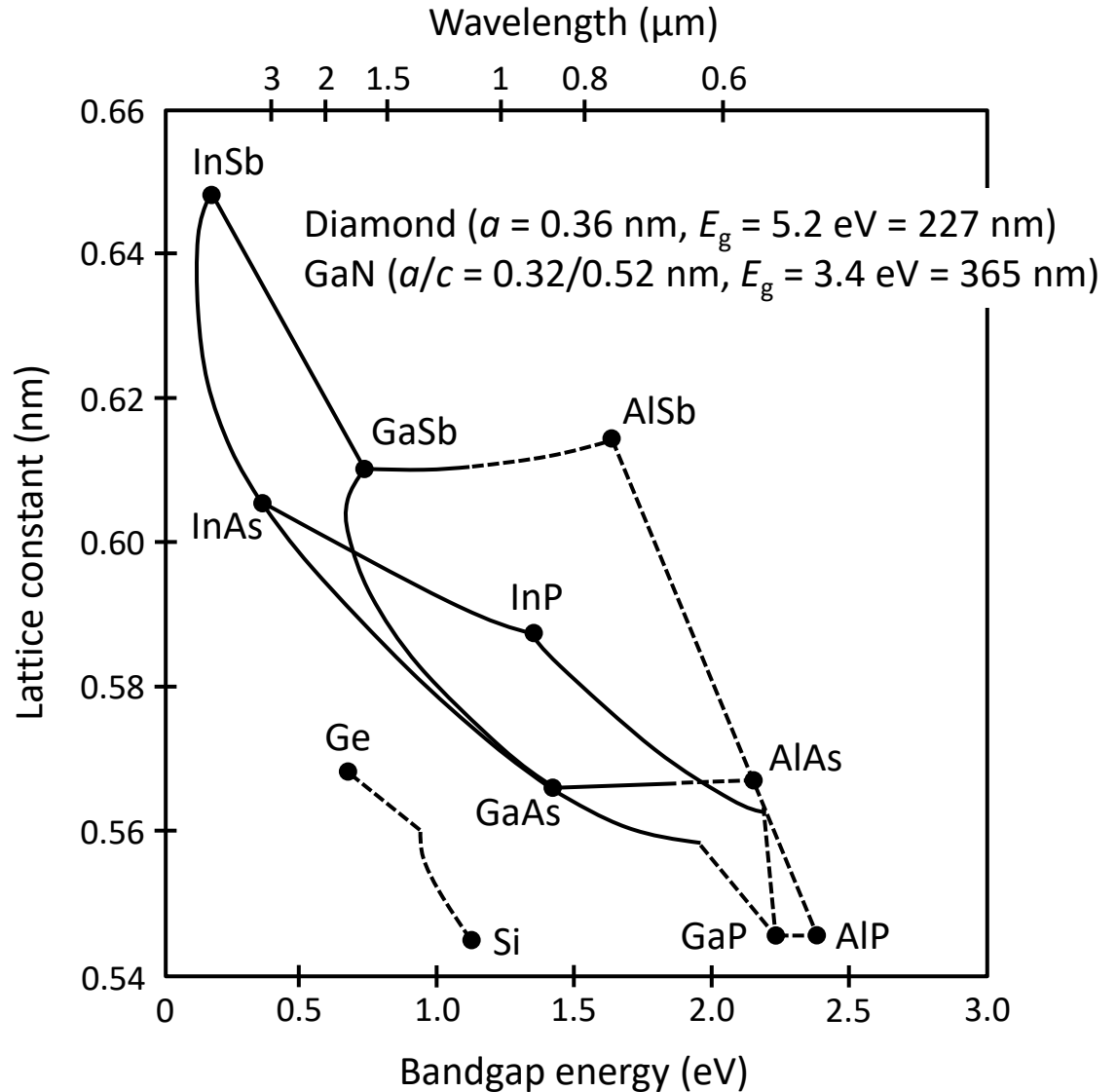
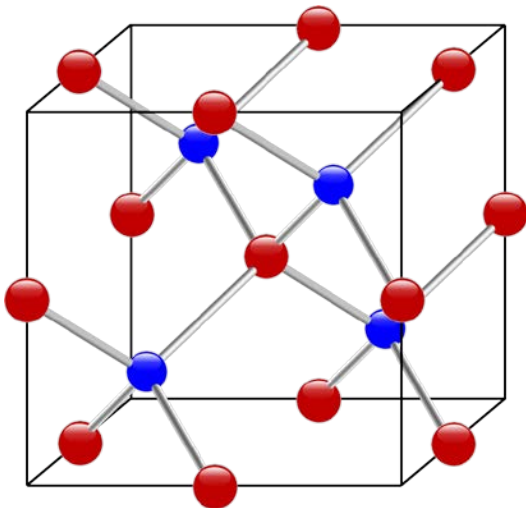

ヘテロ構造による閉じ込め

閉じ込め準位の形成

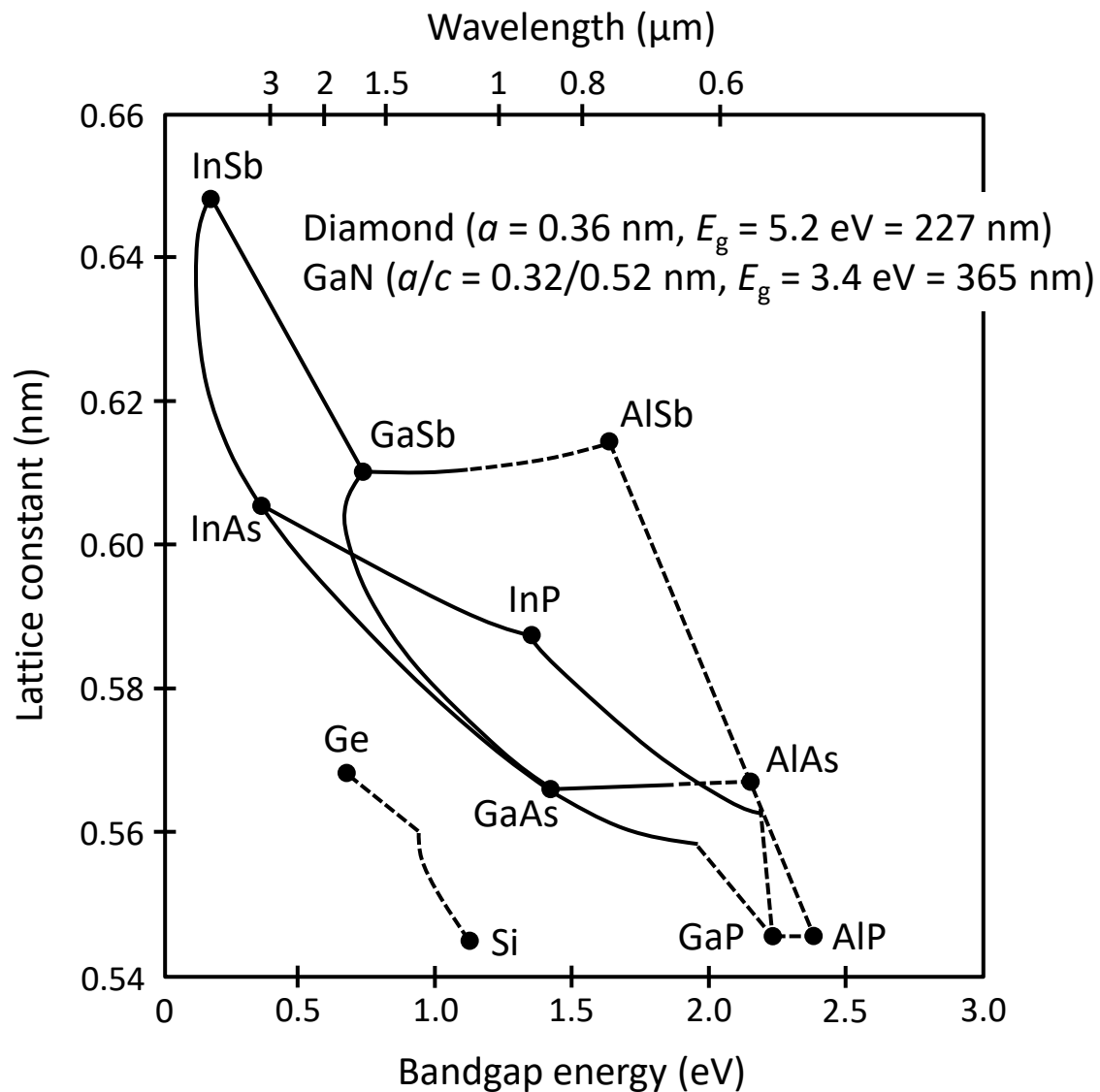
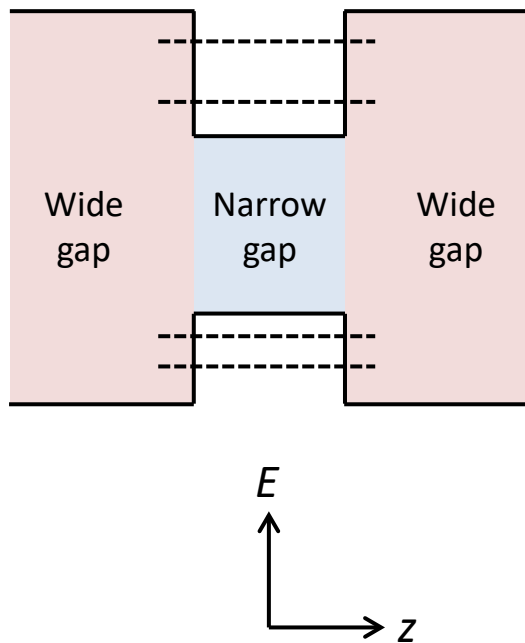

へテロ構造中の電子波動関数

有効質量近似

$$\Psi(\mathbf{r}) = \chi(\mathbf{r})\psi(\mathbf{r})$$

包絡関数

箱の中の粒子

ブロッホ関数

バルクの性質を反映

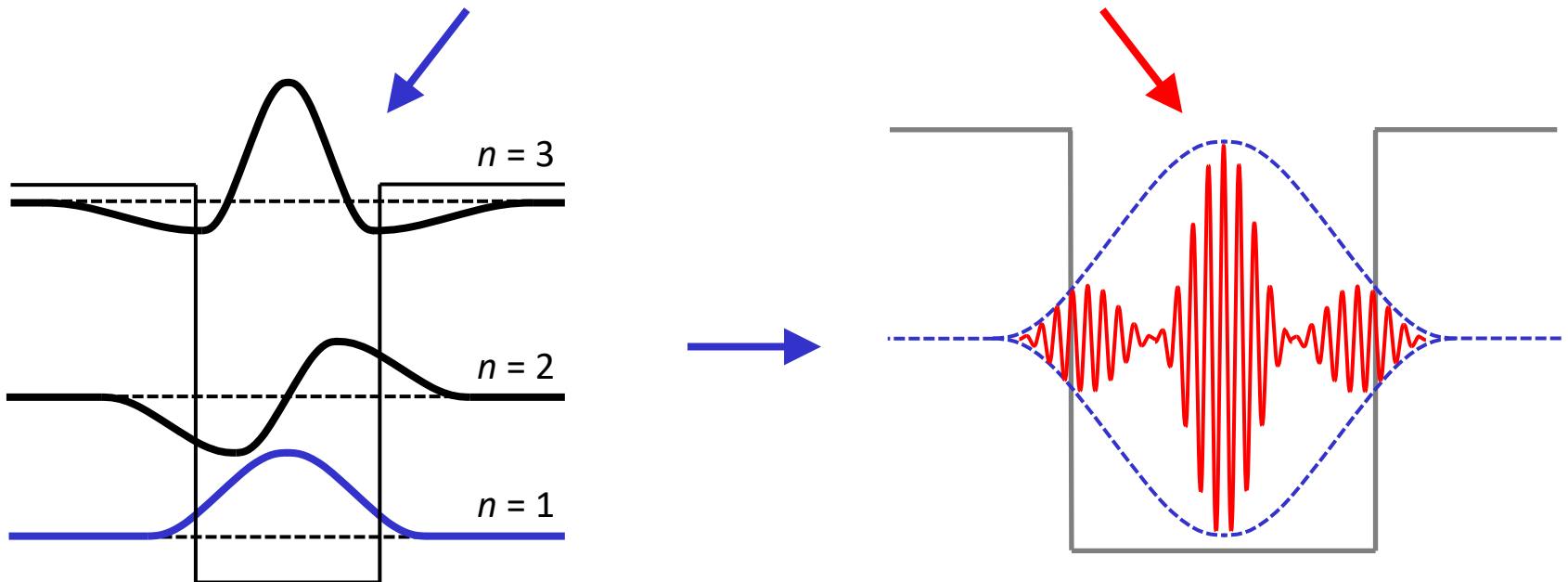

講義内容

- 半導体デバイスとノーベル賞
- 周期ポテンシャルとバンドギャップ
- 有効質量近似

講義内容

- **半導体デバイスとノーベル賞**
- 周期ポテンシャルとバンドギャップ
- 有効質量近似

半導体デバイスとノーベル賞

- **トランジスタ**
 - Shockley, Bardeen & Brattain (1947発明 → 1956受章)
- **トンネルダイオード**
 - Esaki (1957 → 1973)
- **ヘテロ構造**
 - Alferov & Kroemer (1960's → 2000)
- **集積回路**
 - Kilby (1959 → 2000)
- **電荷結合素子(CCD)**
 - Boyle & Smith (1969 → 2009)
- **青色LED**
 - Akasaki, Amano & Nakamura (1990's → 2014)

半導体デバイスとノーベル賞

- **トランジスタ**
 - Shockley, Bardeen & Brattain (1947発明 → 1956受章)
- **トンネルダイオード**
 - Esaki (1957 → 1973)
- **ヘテロ構造**
 - Alferov & Kroemer (1960's → 2000)
- **集積回路**
 - Kilby (1959 → 2000)
- **電荷結合素子(CCD)**
 - Boyle & Smith (1969 → 2009)
- **青色LED**
 - Akasaki, Amano & Nakamura (1990's → 2014)

大別すると **トランジスタ技術** と **バンドエンジニアリング**

点接触トランジスタ

“for their researches on semiconductors and their discovery of the transistor effect” (Physics, 1956)

Oct. 3, 1950
 Filed June 17, 1948
J. BARDEEN ET AL
 THREE-ELECTRODE CIRCUIT ELEMENT UTILIZING SEMICONDUCTIVE MATERIALS
 2,524,035
 3 Sheets-Sheet 1

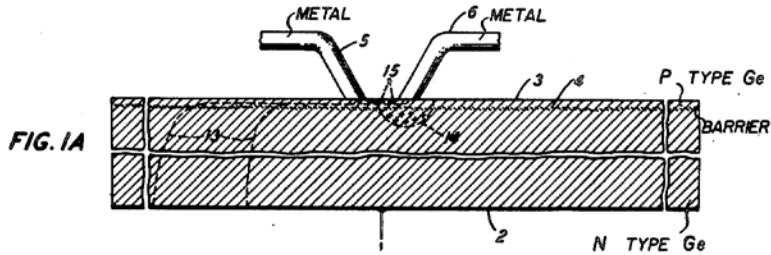
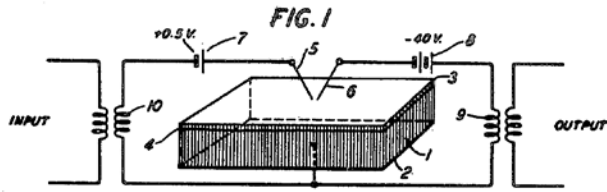

INVENTORS: **J. BARDEEN**
W. H. BRATTAIN
 BY *Harry C. Hart*
 ATTORNEY

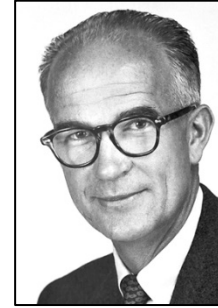

Shockley



Bardeen

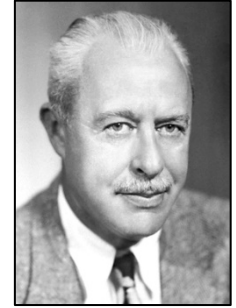

Brattain

© Nobel Foundation

© Alcatel-Lucent



“Three-electrode circuit element utilizing semiconductive materials”
 US2524035 (Filed on June 17, 1948)

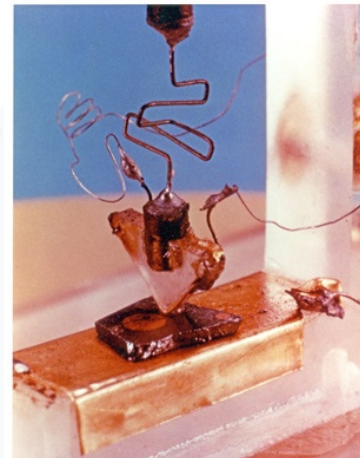

from Computer History Museum, The Silicon Engine

バイポーラトランジスタ

Sept. 25, 1951

W. SHOCKLEY

2,569,347

CIRCUIT ELEMENT UTILIZING SEMICONDUCTIVE MATERIAL

Filed June 26, 1948

3 Sheets-Sheet 2

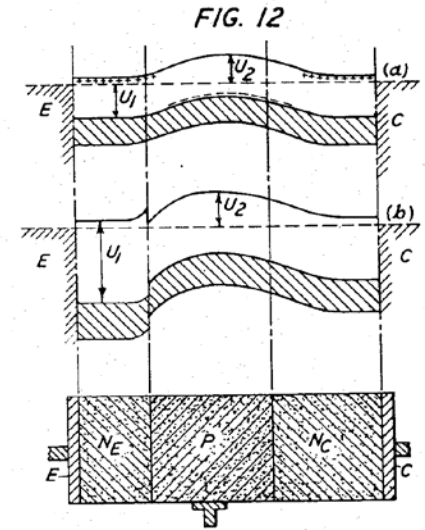
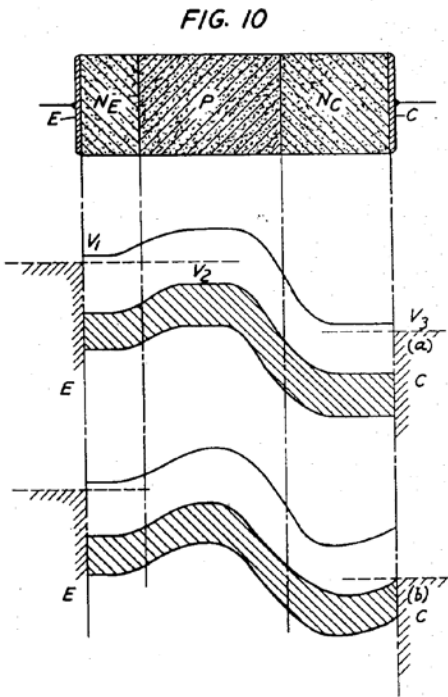
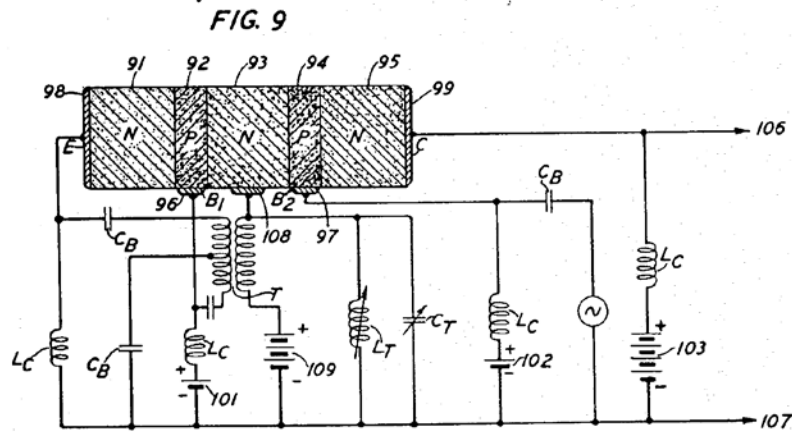

"Circuit element utilizing semiconductive material"
US2569347 (Filed on June 26, 1948)

INVENTOR
W. SHOCKLEY
BY
A. Guntter
ATTORNEY

Bell Labs (1936)
↓
Shockley Semi. Lab. (1956)
↓
Stanford (1963)

Shockley

© Alcatel-Lucent

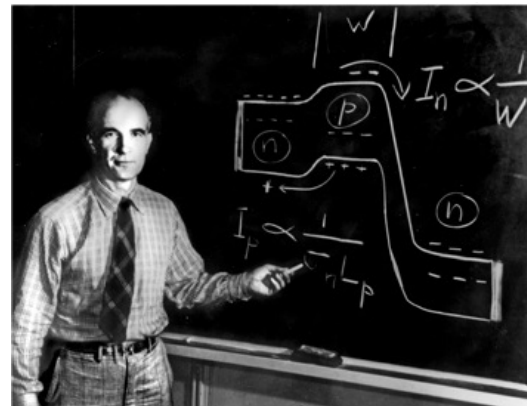

集積回路

“for his part in the invention of the integrated circuit” (Physics, 2000)

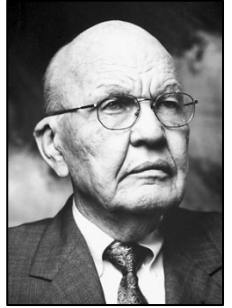

Kilby

© Nobel Foundation

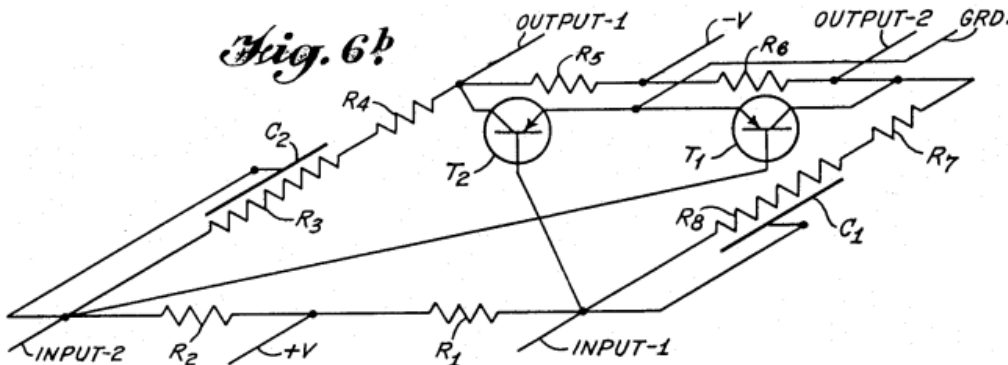
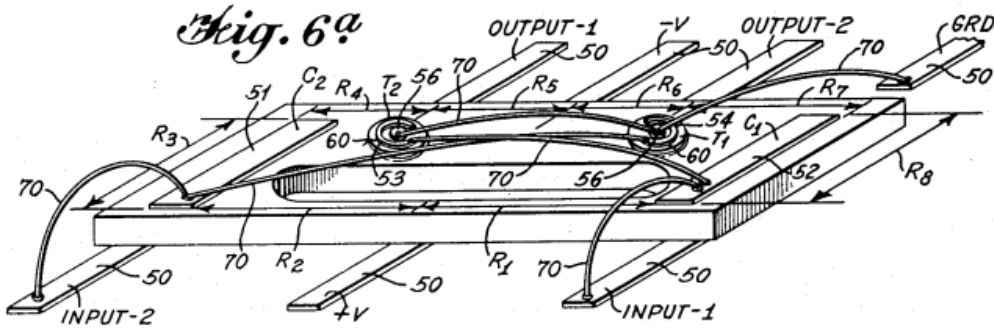

Filed Feb. 6, 1959
June 23, 1964

J. S. KILBY
MINIATURIZED ELECTRONIC CIR

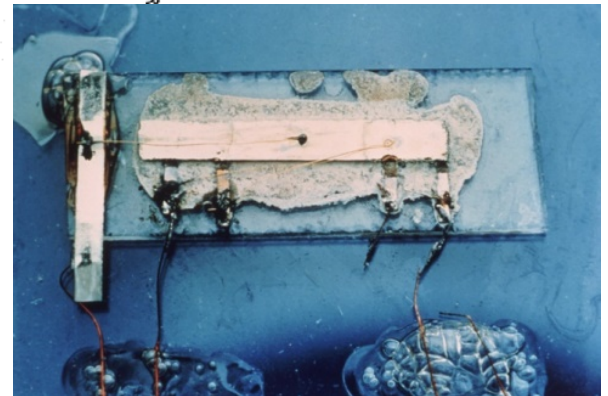

© Texas Instruments

“Miniaturized electronic circuits”
US3138743 (Filed on Feb 6, 1959)

BY
Stewart, Davis, Millar & Smith
ATTORNEYS

Jack S. Kilby
INVENTOR

集積回路

April 25, 1961

R. N. NOYCE

2,981,877

SEMICONDUCTOR DEVICE-AND-LEAD STRUCTURE

Filed July 30, 1959

3 Sheets-Sheet 2

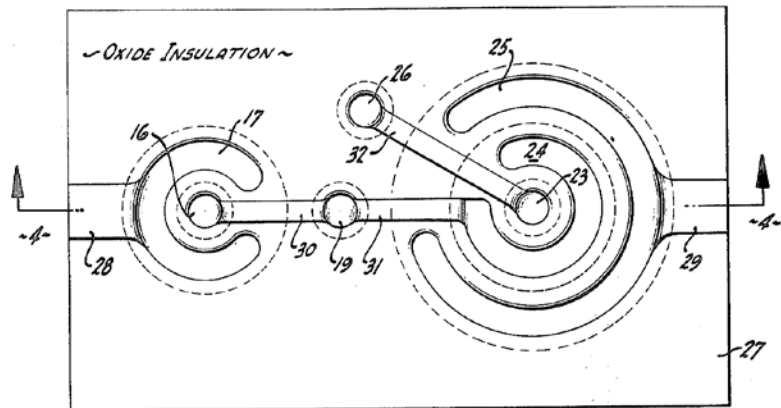

FIG-3

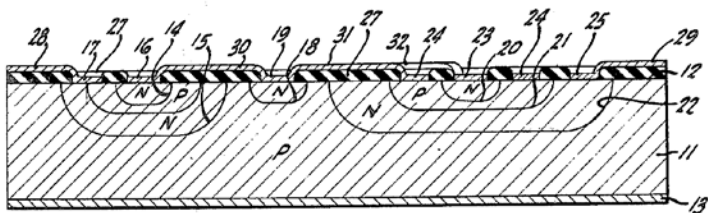

FIG-4

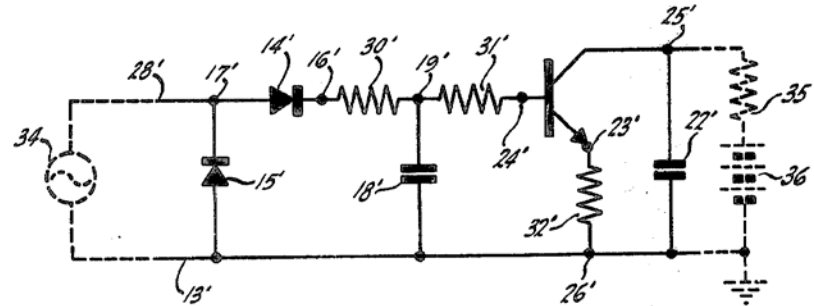
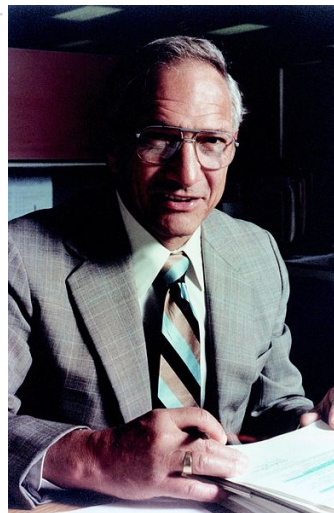

FIG-5

INVENTOR.
ROBERT N. NOYCE
BY *Lippincott & Kalls*
ATTORNEYS



Noyce
'Mayor of Silicon Valley'

from Wikipedia

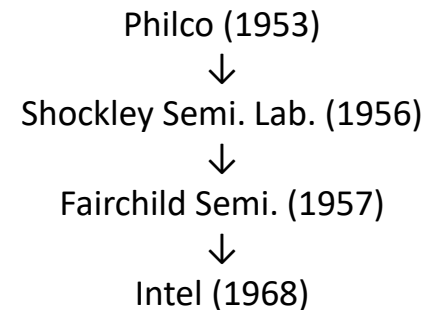

"Semiconductor Device-and-Lead Structure"
US2981877 (Filed on July 30, 1959)

MOSトランジスタ

Aug. 27, 1963

DAWON KAHNG

3,102,230

ELECTRIC FIELD CONTROLLED SEMICONDUCTOR DEVICE

Filed May 31, 1960

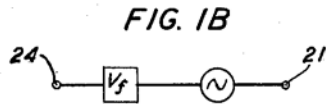
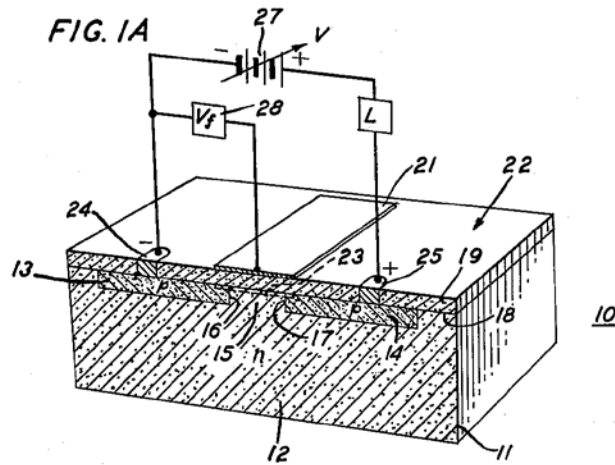
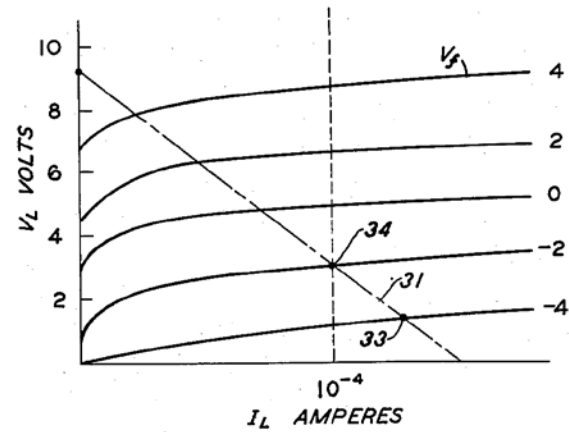

FIG. 2



INVENTOR
D. KAHNG
BY *H. W. Lockhart*
ATTORNEY



Kahng
from CRN

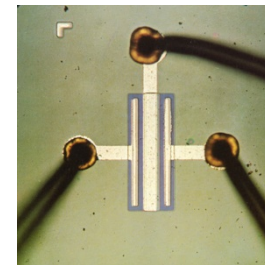

FI 100
© Fairchild

“Electric field controlled semiconductor device”
US3102230 (Filed on May 31, 1960)

CCD

“for the invention of an imaging semiconductor circuit - the CCD sensor”
(Physics, 2009)

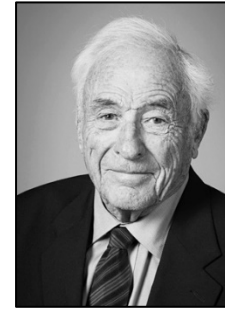

Boyle



Smith

© Nobel Foundation

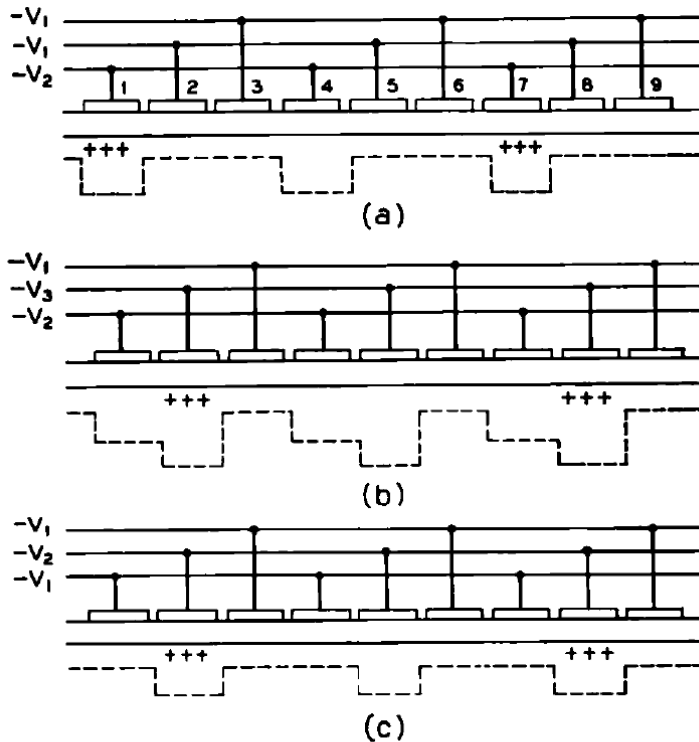

Fig. 2—Schematic of a three phase MIS charge coupled device.

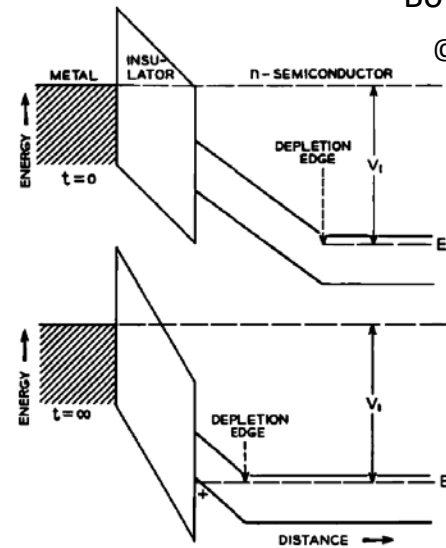
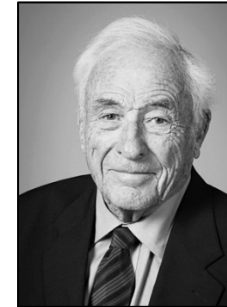

Fig. 1—A plot of electron energy vs distance through an MIS structure both with (at time $t = \infty$) and without (at time $t = 0$) charge stored at the surface.

“Charge Coupled Semiconductor Devices” Bell Sys. Tech. J. **49**, 587 (1970) Boyle & Smith

CCD

“for the invention of an imaging semiconductor circuit - the CCD sensor”
(Physics, 2009)



Boyle



Smith

© Nobel Foundation

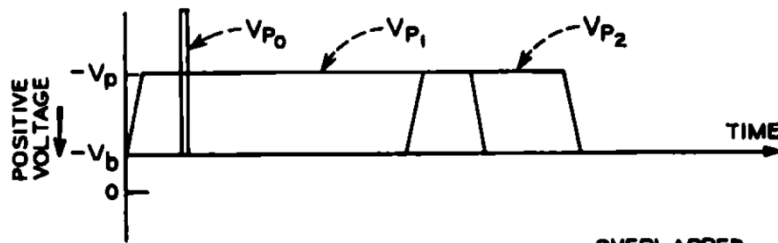

OVERLAPPED
VOLTAGE PULSES

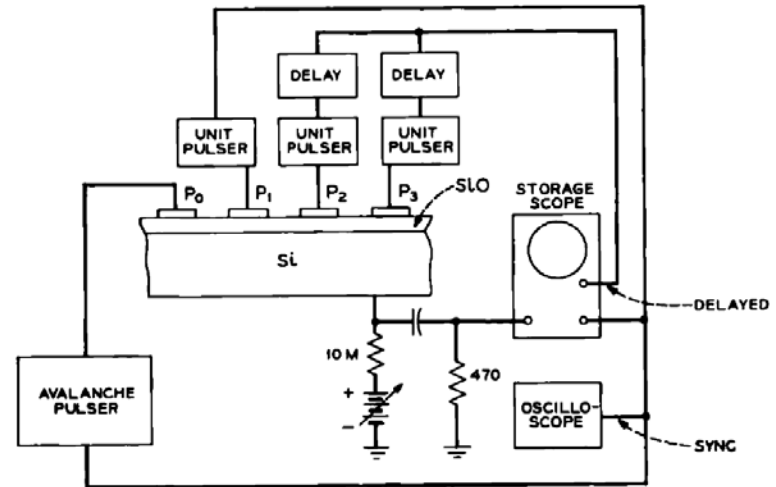
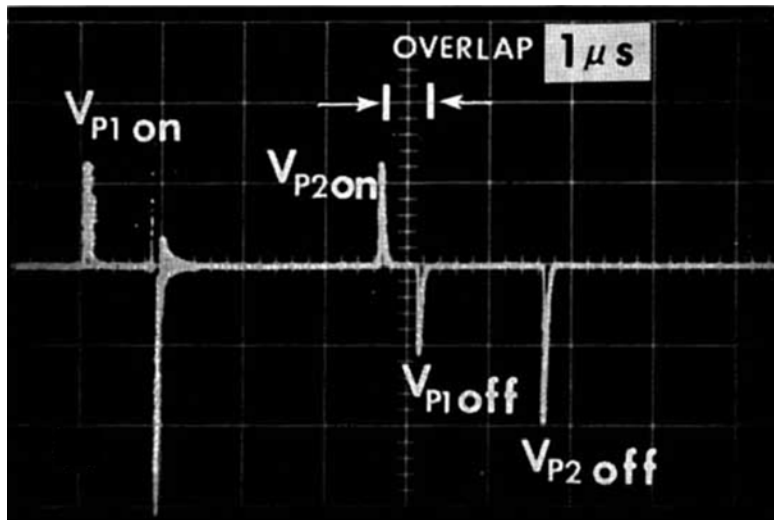

Fig. 1—Schematic of experimental configuration used to evaluate charge transfer.

“Experimental verification of the charge coupled device concept”
Bell Sys. Tech. J. **49**, 593 (1970) Amelio, Tomsett & Smith

トンネルダイオード

“for their experimental discoveries regarding tunneling phenomena in semiconductors and superconductors, respectively” (with Giaever, Physics, 1973)



Esaki

© Nobel Foundation

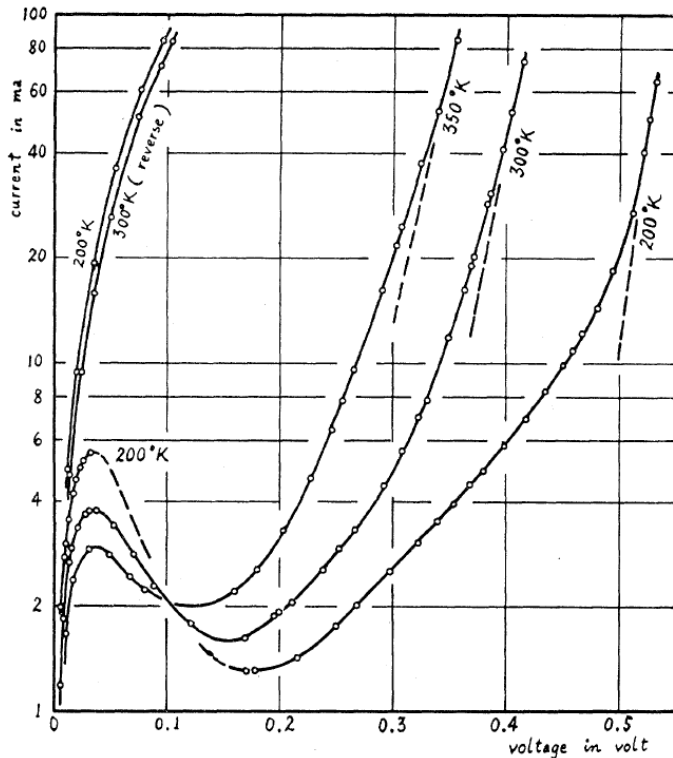

FIG. 1. Semilog plots of the measured current-voltage characteristic at 200°K, 300°K, and 350°K.

New Phenomenon in Narrow Germanium p - n Junctions

LEO ESAKI

Tokyo Tsushin Kogyo, Limited, Shinagawa, Tokyo, Japan
(Received October 11, 1957)

Phys. Rev. **109**, 603 (1958)

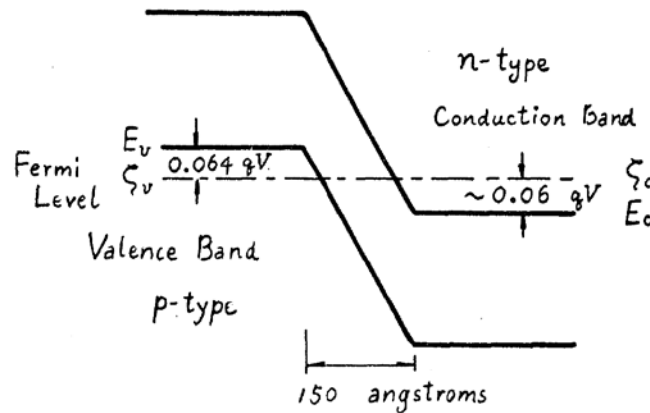

FIG. 2. Energy diagram of the p - n junction at 300°K and no bias voltage.

トンネルダイオード

“for their experimental discoveries regarding tunneling phenomena in semiconductors and superconductors, respectively” (with Giaever, Physics, 1973)



Esaki

© Nobel Foundation

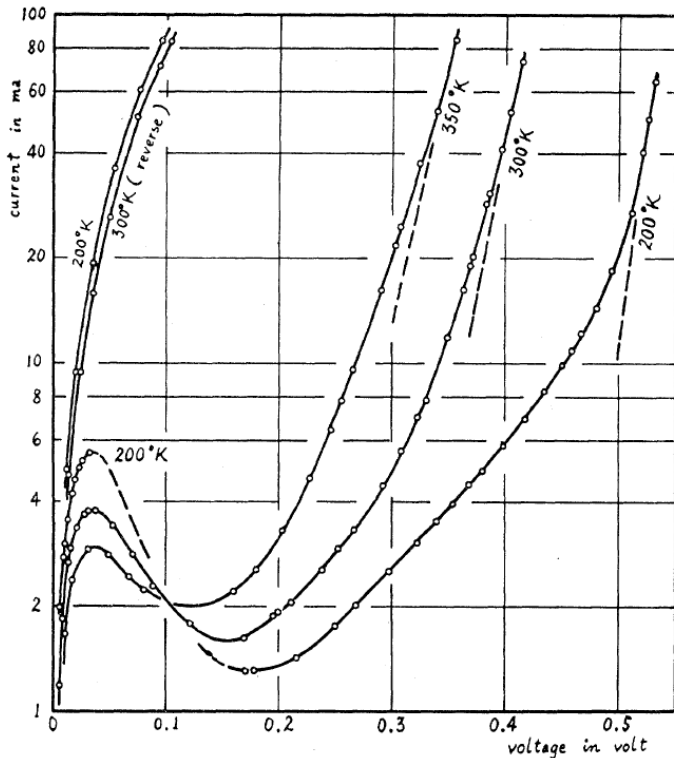

FIG. 1. Semilog plots of the measured current-voltage characteristic at 200°K, 300°K, and 350°K.

DATE Aug 14 1955
CASE No. 1

As shown in preceding hand file
in notes, the tunneling and breakdown
will be possible. Tunneling will be
possible because of equal energy electrons
of the same energy and under
the condition stated above, however no
allowed states of same energy in the
adjacent conduction bands. Unstable
lowest energy because an electron on left
falling over the potential step must give
up energy equal to that necessary to
create a hole-electron pair. Consequently,
the current will drop as the applied bias
is increased. Finally, at higher
biases, the normal diode forward
characteristic will be observed.

I_a

R. P. Noyce August 4, 1955

Noyce's note in 1956

© Stanford University Library

50年後

Esaki diode is still a radio star, half a century on

An FM transistor radio owned by one of us (L. E.) since the early 1960s still works beautifully. Reasoning that this was testament to the performance of its single Esaki diode, we tested the effects of storage on some of these germanium devices made in 1960.

The Esaki diode (L. Esaki *Phys. Rev.* **109**, 603-604; 1958) was the first quantum-electron

device. Unlike the mechanism that powers most semiconductor devices, current flows through the diode as a result of quantum-mechanical electron tunnelling across a potential barrier.

Semiconductor transport devices are extremely stable, so their shelf-life should be infinite if they are stored at room temperature. But the Esaki diode's tunnel current is very sensitive to its enormous built-in electric field in the junction region (E. Spenke *Electronic Semiconductors* 232; McGraw-Hill, 1958), which could affect its long-term performance.

As the most likely indicator of any small structural changes in the device, we re-measured the peak current in 20 devices and discovered that it had fallen by an average of just 3.3% over 50 years, corresponding to a junction widening of only 0.25%.

This very tiny shift in electronic characteristics is probably down to inbuilt impurities and imperfections within the structure. A gratifying confirmation of the diode's longevity, nonetheless.

超格子

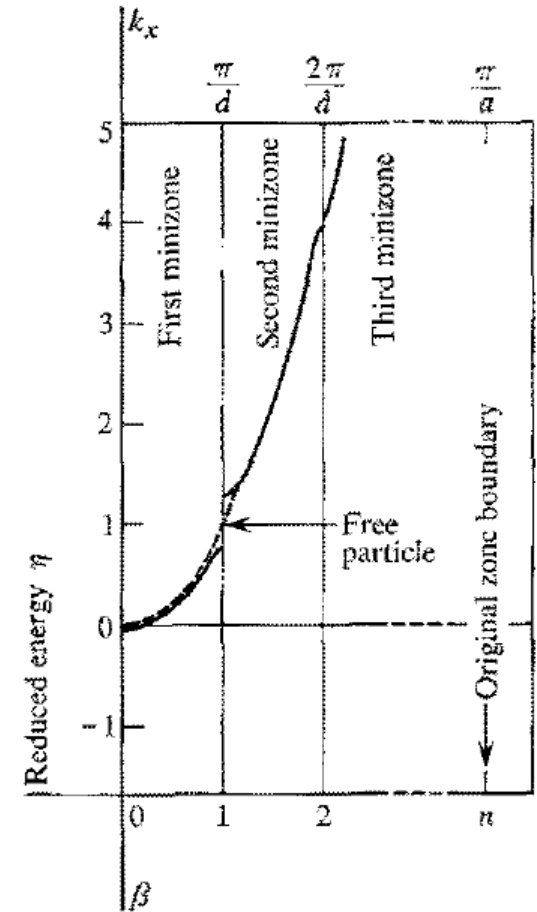
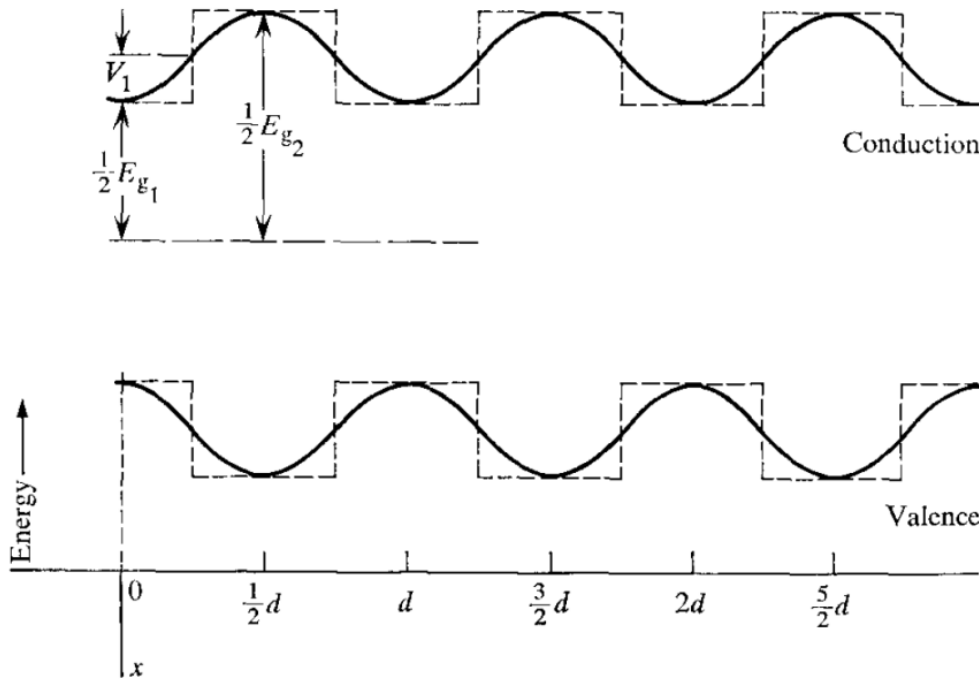

... Although it may be a **formidable task** to construct the proposed superlattice, we believe that efforts directed to this end **will open new areas of investigation in the field of semiconductor physics.**

“Superlattice and Negative Differential Conductivity in Semiconductors”

IBM J. Res. Devel. **14**, 61 (1970) Esaki & Tsu

超格子

... the original version of the paper was **rejected** for publication **by Physical Review** on the **referee's unimaginative assertion** that it was **“too speculative”** and involved **“no new physics”**. The shortened version published in IBM Journal of Research and Development was selected as a **Citation Classic** by the Institute for Scientific Information (ISI) in July 1987. Our 1969 proposal was cited as **one of the most innovative ideas** at the ARO 40th Anniversary Symposium in Durham, North Carolina, 1991.

“The Birth of the Semiconductor Superlattice” by Esaki
in *Fundamentals of Semiconductors*, Yu & Cardona

バンドエンジニアリング

共鳴トンネルダイオード → 縦型量子ドット (1996)

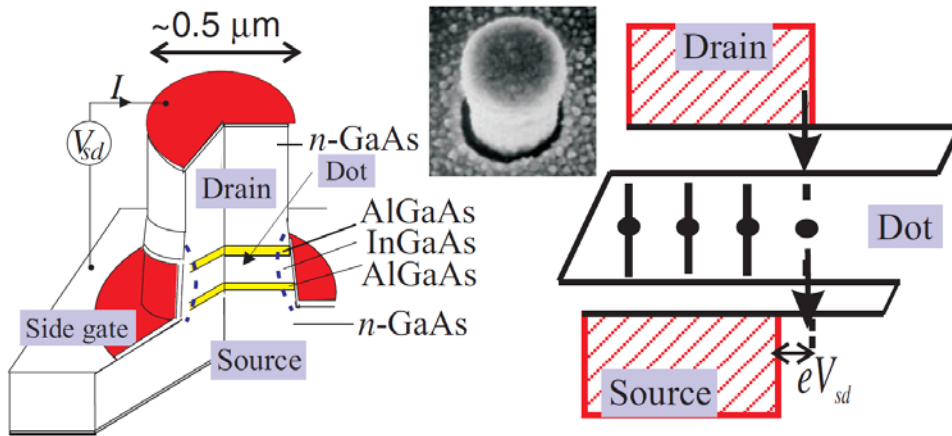

Rep. Prog. Phys. **64**, 701 (2001) Kouwenhoven *et al.*

VCSEL (1988)

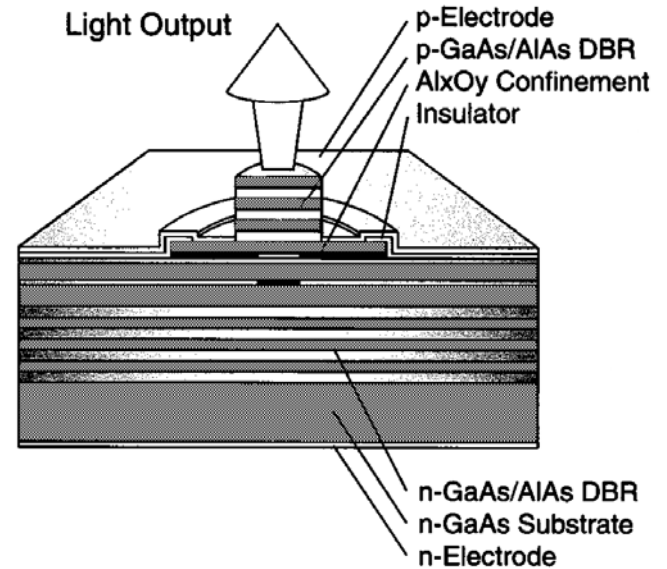

IEEE Selec. Topics QE **6**, 1201 (2000) Iga

量子カスケードレーザー (1994)

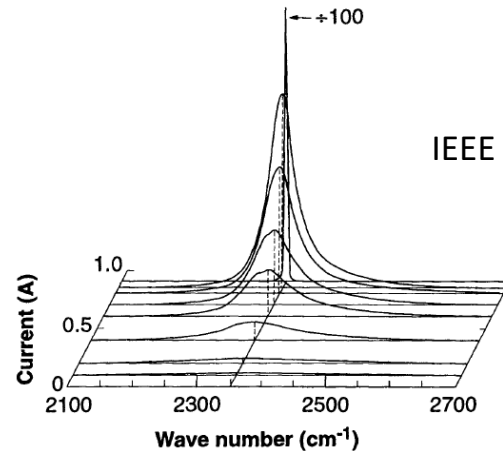
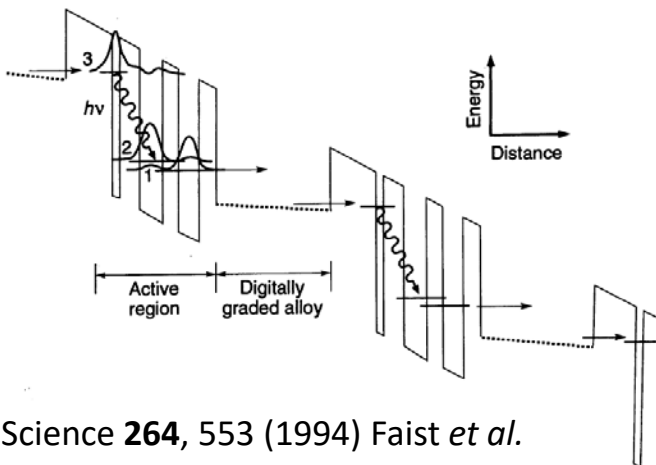

Science **264**, 553 (1994) Faist *et al.*

へテロ構造

“for developing semiconductor heterostructures used in high-speed- and opto-electronics” (Physics, 2000)

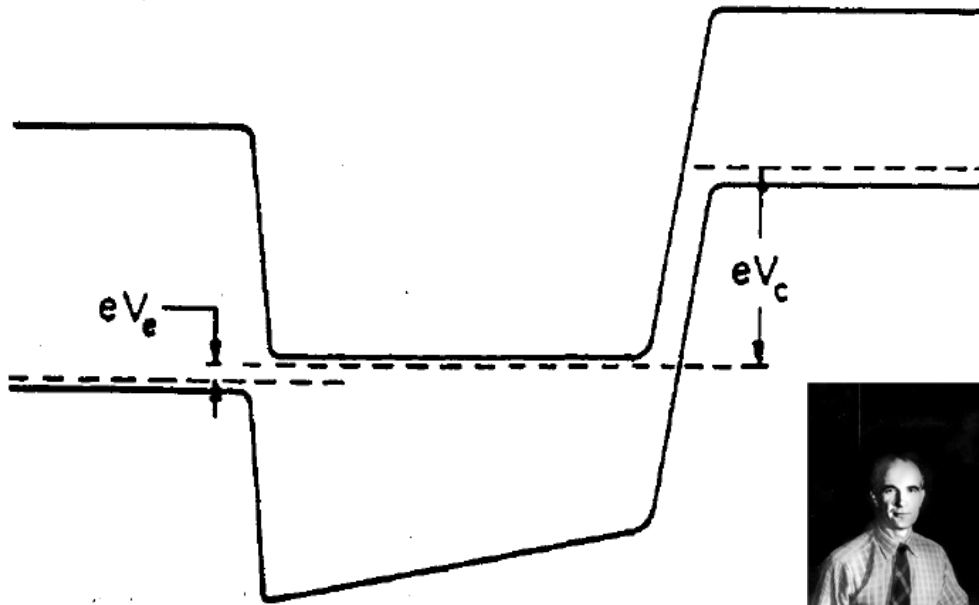

Alferov

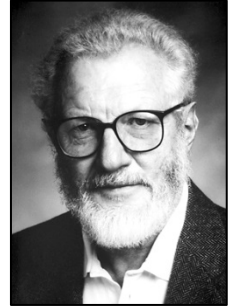

Kroemer

© Nobel Foundation

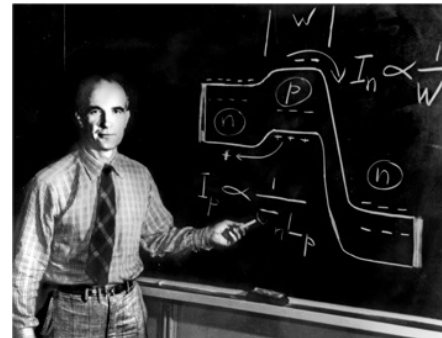

Shockley (1951)

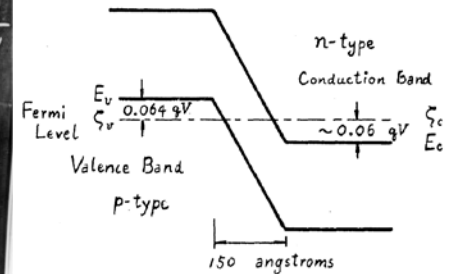

Esaki (1958)

“Quasi-Electric and Quasi-Magnetic Fields in Non-Uniform Semiconductors”
 RCA Review **18**, 332 (1957) Kroemer

へテロ構造

“for developing semiconductor heterostructures used in high-speed- and opto-electronics” (Physics, 2000)



Alferov

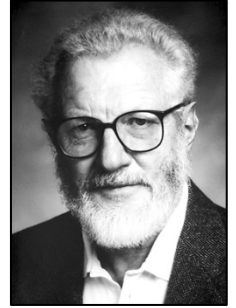

Kroemer

© Nobel Foundation

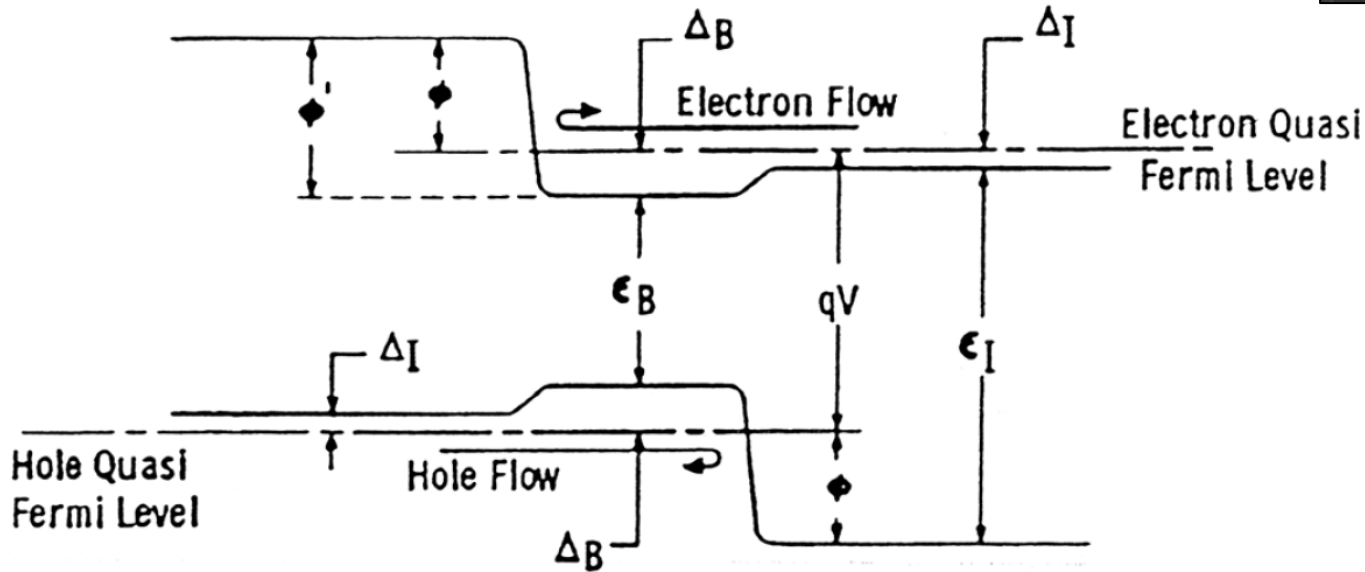

“A Proposed Class of Hetero-junction Injection Lasers” Proc. IEEE **51**, 1782 (1963) Kroemer

へテロ構造

“for developing semiconductor heterostructures used in high-speed- and opto-electronics” (Physics, 2000)

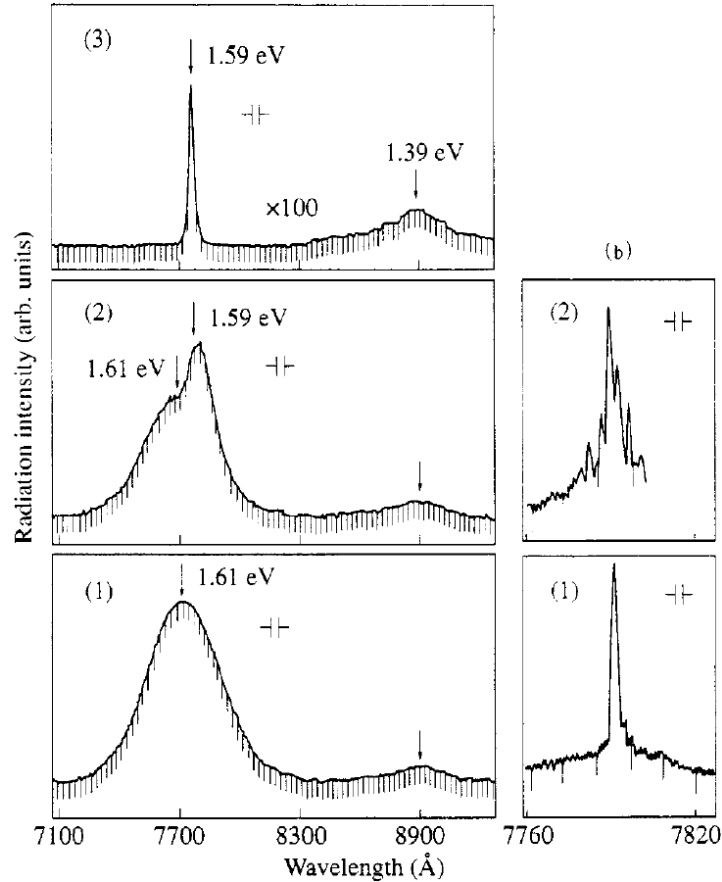

Alferov

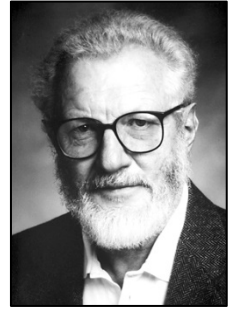

Kroemer

© Nobel Foundation

Fig. 1. Radiation spectrum for the first low room-temperature threshold Al_xGa_{1-x}As DHS laser 300 K. $J_{th} = 4300 \text{ A/cm}^2$. Current increases from 0.7 A(1) to 8.3 A(2) and to 13.6 A(3).

“AlAs-GaAs heterojunction injection lasers with a low room-temperature threshold”
Fiz. Tekn. Polupr. **3**, 1328 (1969) Alferov *et al.*

青色LED

“for the invention of efficient blue light-emitting diodes which has enabled bright and energy-saving white light sources” (Physics, 2014)



Akasaki



Amano



Nakamura

© Nobel Foundation

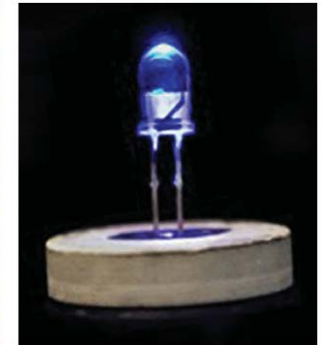
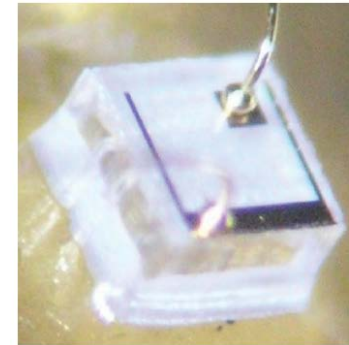
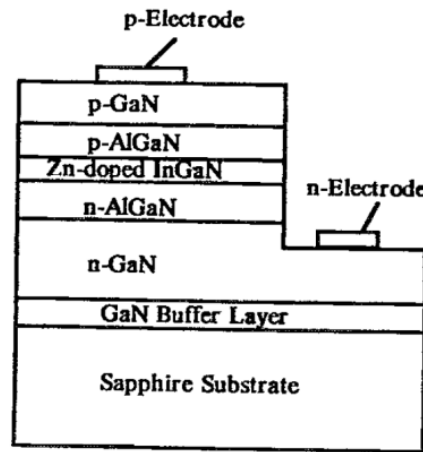
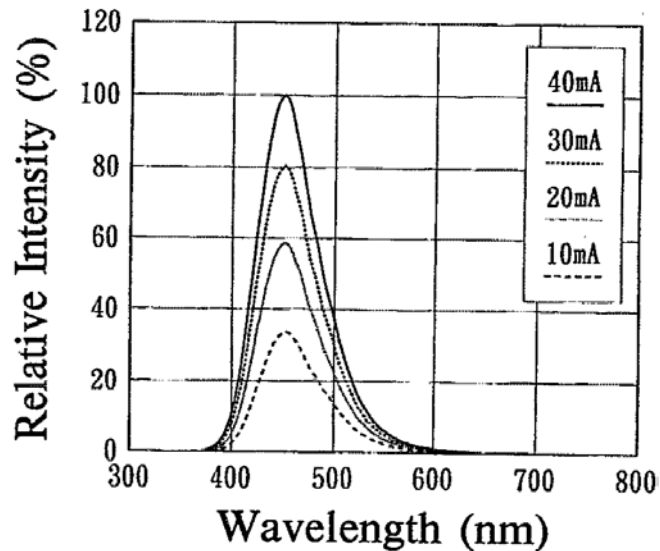

from Nobel Lecture by Nakamura

“Candela-class high-brightness InGaIn/AlGaIn double-heterostructure blue-light-emitting diodes”
Appl. Phys. Lett. **64**, 1687 (1994) Nakamura *et al.*

青色LED

“for the invention of efficient blue light-emitting diodes which has enabled bright and energy-saving white light sources” (Physics, 2014)



Akasaki



Amano



Nakamura

© Nobel Foundation

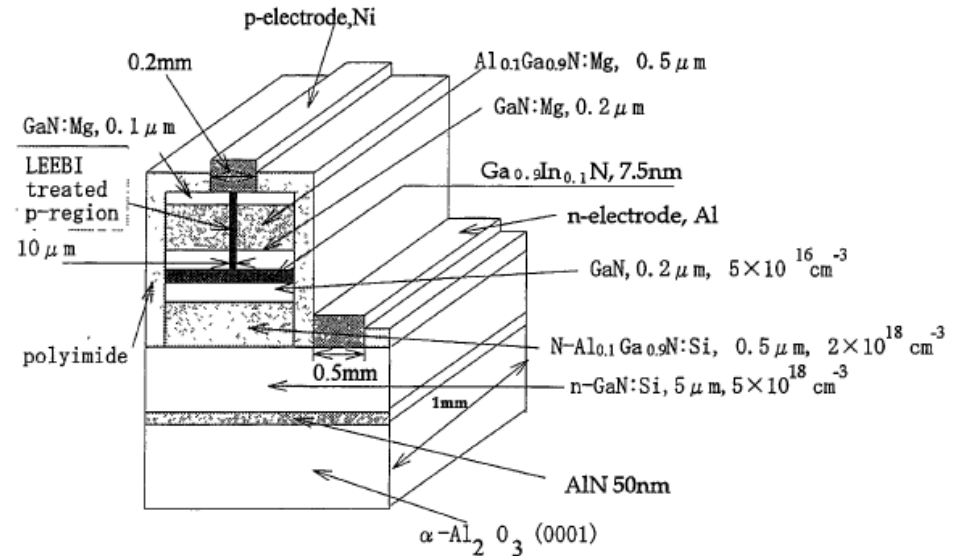
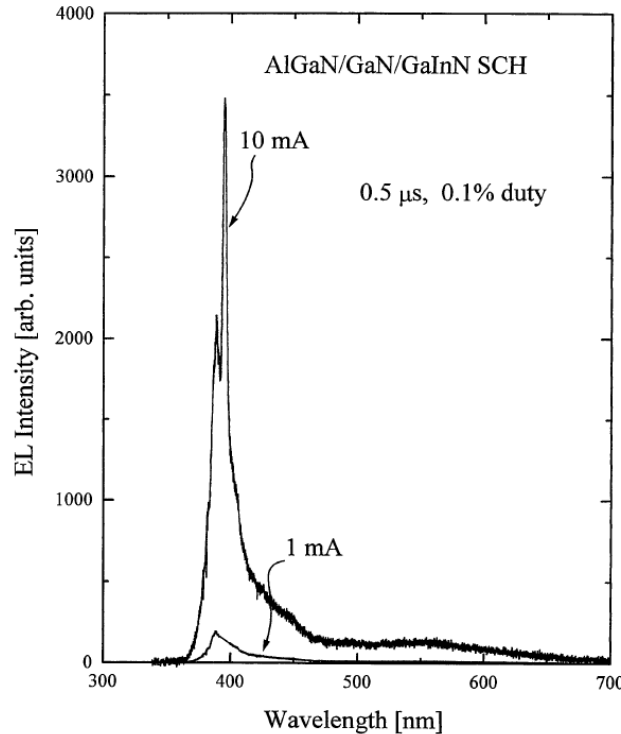

“Stimulated Emission by Current Injection from an AlGaInN Quantum Well Device”
 Jpn. J. Appl. Phys. **34**, L1517 (1995) Akasaki, Amano *et al.*

講義内容

- 半導体デバイスとノーベル賞
- **周期ポテンシャルとバンドギャップ**
- 有効質量近似

分子軌道の観点から

s/p 軌道が結合/反結合状態を形成して分裂

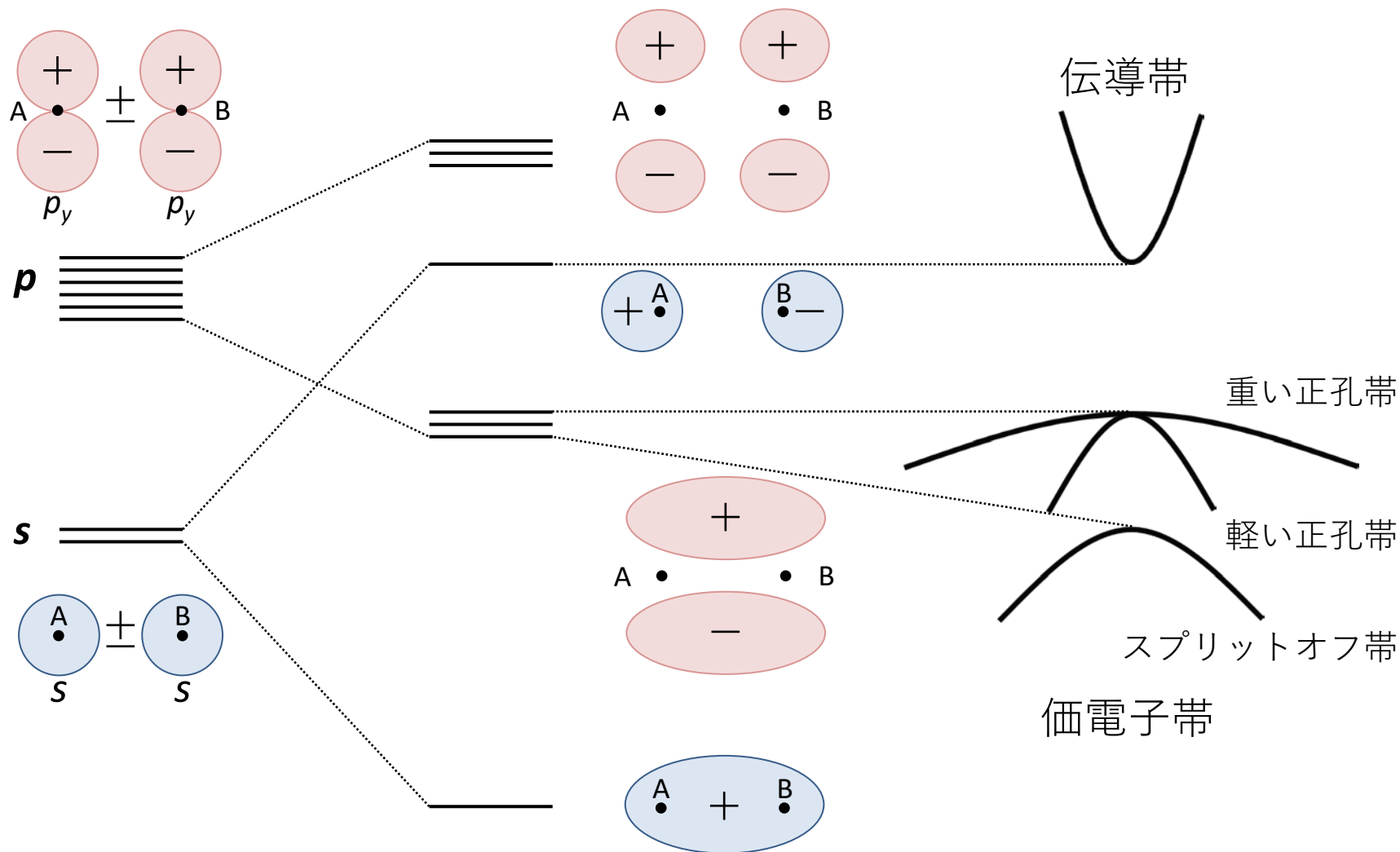

自由電子近似の観点から

右向きと左向きの進行波が $k = \pi/a$ でブラッグ反射して定在波を形成

同位相 $\psi_+(x) = e^{i\pi x/a} + e^{-i\pi x/a} = 2 \cos(\pi x/a)$

逆位相 $\psi_-(x) = e^{i\pi x/a} - e^{-i\pi x/a} = 2i \sin(\pi x/a)$

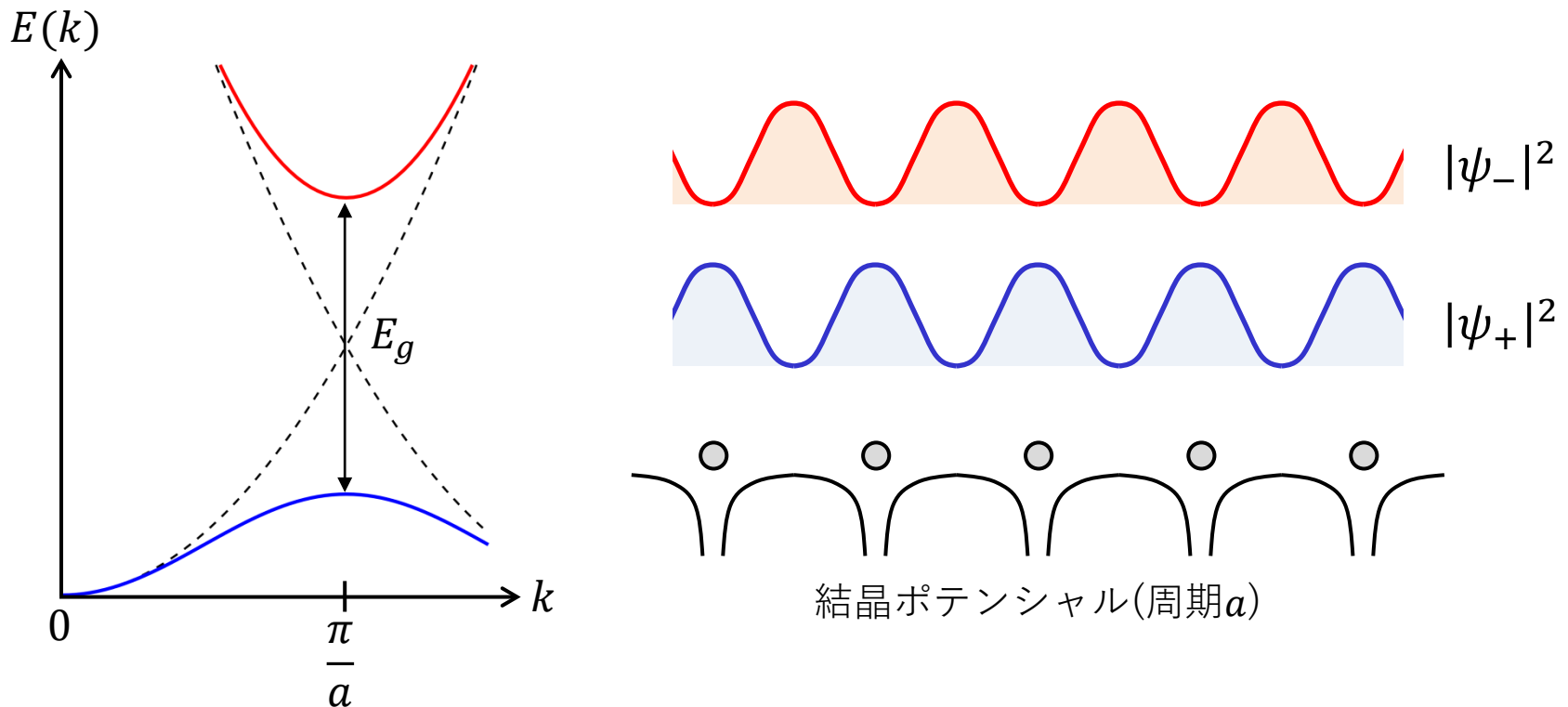

1D周期ポテンシャル中の電子

ポテンシャル形状を仮定せずに一般論を進める

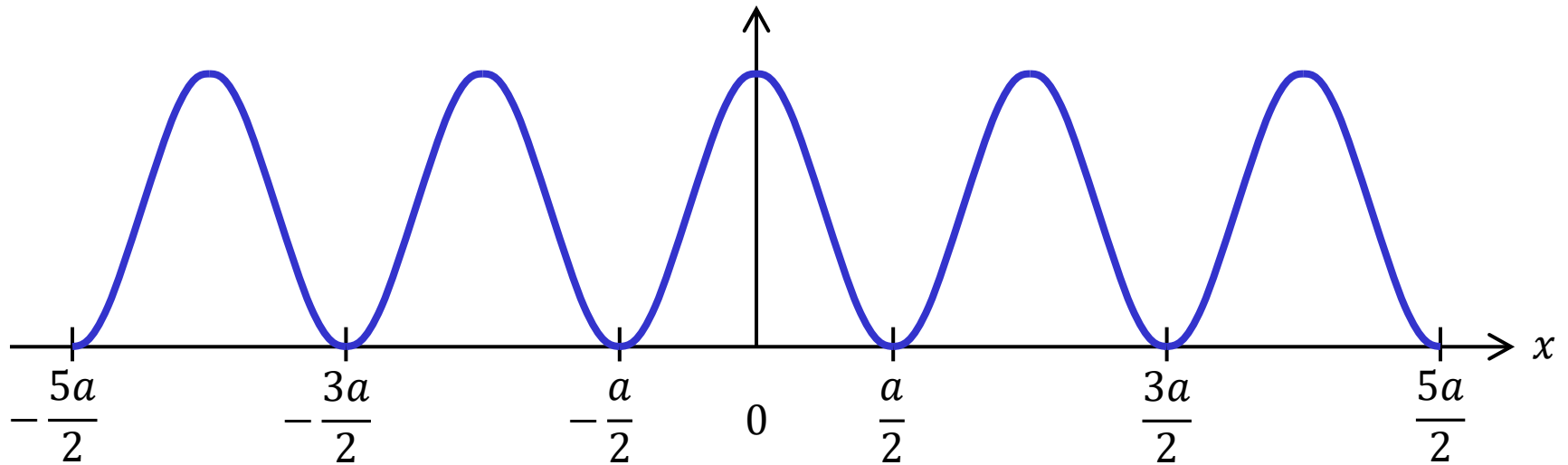

単独の障壁ポテンシャル(偶関数)

$$v(x) = v(-x) \quad -\frac{a}{2} \leq x \leq \frac{a}{2}$$

$$V(x) = \sum_{n=-\infty}^{\infty} v(x + na)$$

$$V(x + na) = V(x)$$

シュレディンガー方程式

周期的境界条件付の自由電子

$$H_0\varphi(x) = -\frac{\hbar^2}{2m} \frac{d^2}{dx^2} \varphi(x) = \epsilon\varphi(x) \quad \varphi(x + Na) = \varphi(x)$$

$$\Rightarrow \varphi_k(x) = e^{ikx} \quad \epsilon = \frac{\hbar^2 k^2}{2m} \quad k = \frac{2\pi}{Na} p \quad (p = 0, \pm 1, \pm 2, \dots)$$

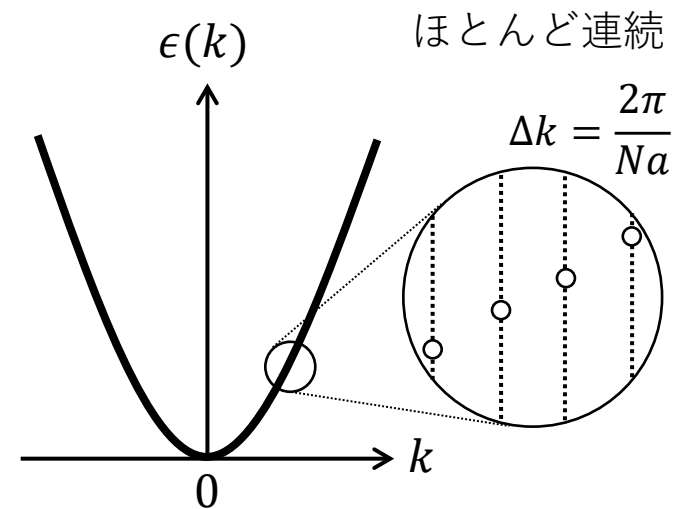
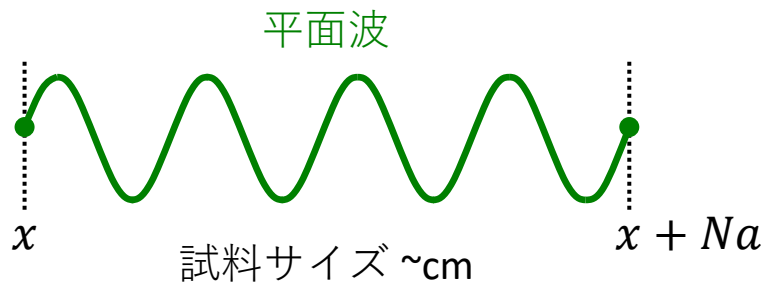

さらに格子周期のポテンシャルが加わる

$$H\psi(x) = [H_0 + V(x)]\psi(x) = \epsilon\psi(x)$$

ブロッホの定理

並進演算子 $Tf(x) = f(x + a)$ $[T, H] = TH - HT = 0$

$$TH(x)\psi(x) = H(x + a)\psi(x + a) = H(x)T\psi(x)$$

$\psi(x)$ は H と T の同時固有関数なので $T\psi(x) = \lambda\psi(x)$

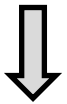

$$\psi(x + a) = e^{ika}\psi(x)$$

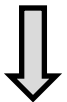

$$\psi(x) = e^{ikx}u_k(x)$$

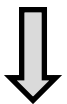

$$u_k(x + a) = u_k(x)$$

$$T^N\psi(x) = \lambda^N\psi(x) = \psi(x)$$

$$\lambda = e^{i\left(\frac{2\pi p}{Na}\right)a} = e^{ika}$$

$$e^{ik(x+a)}u_k(x + a) = e^{ika}(e^{ikx}u_k(x))$$

ブロッホ関数(完全正規直交系): 格子周期で変調された平面波

障壁ポテンシャルへの入反射

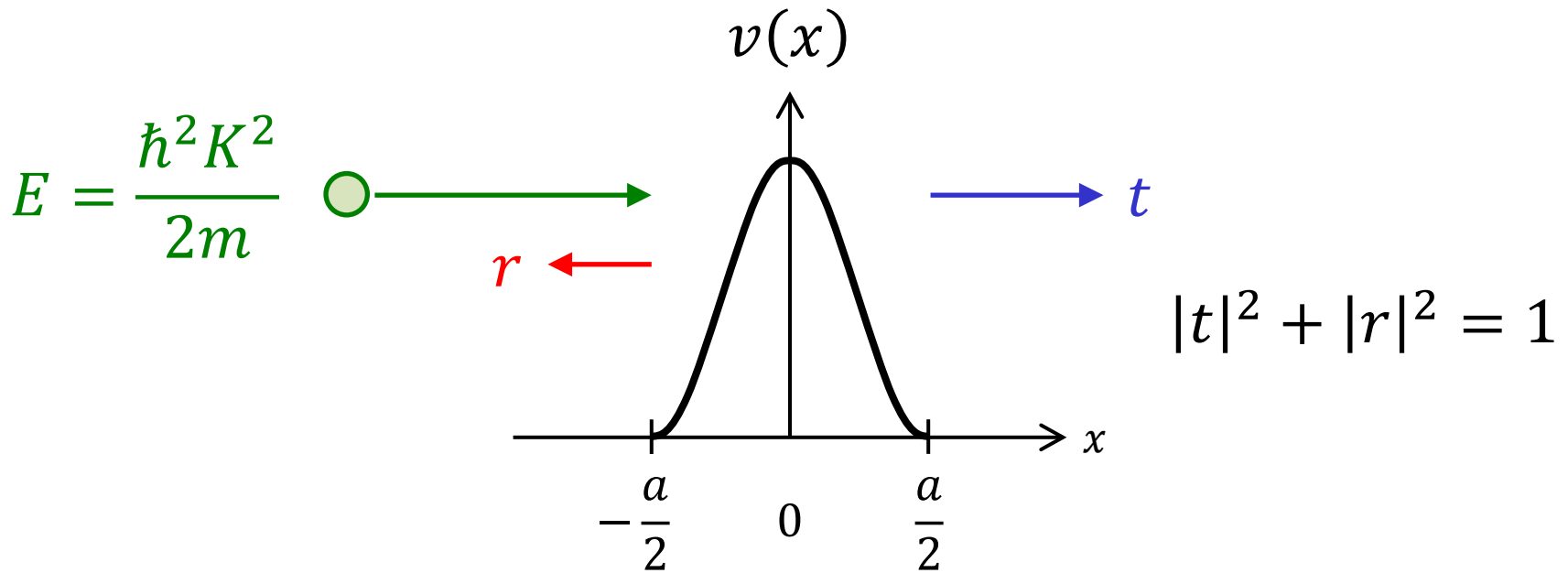

左からの進行波

$$\psi_L(x) = \begin{cases} e^{iKx} + r e^{-iKx} & x \leq -\frac{a}{2} \\ t e^{iKx} & x \geq \frac{a}{2} \end{cases}$$

障壁ポテンシャルへの入反射

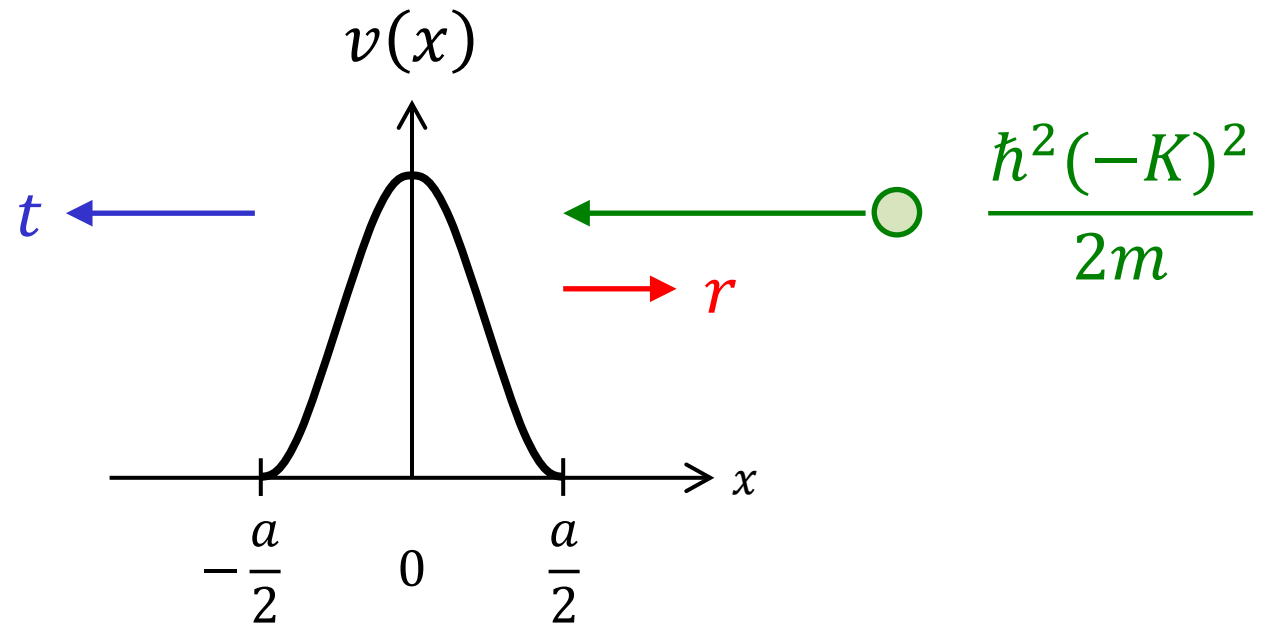

右からの進行波

$$\psi_R(x) = \begin{cases} te^{-iKx} & x \leq -\frac{a}{2} \\ e^{-iKx} + re^{iKx} & x \geq \frac{a}{2} \end{cases}$$

障壁ポテンシャルへの入反射

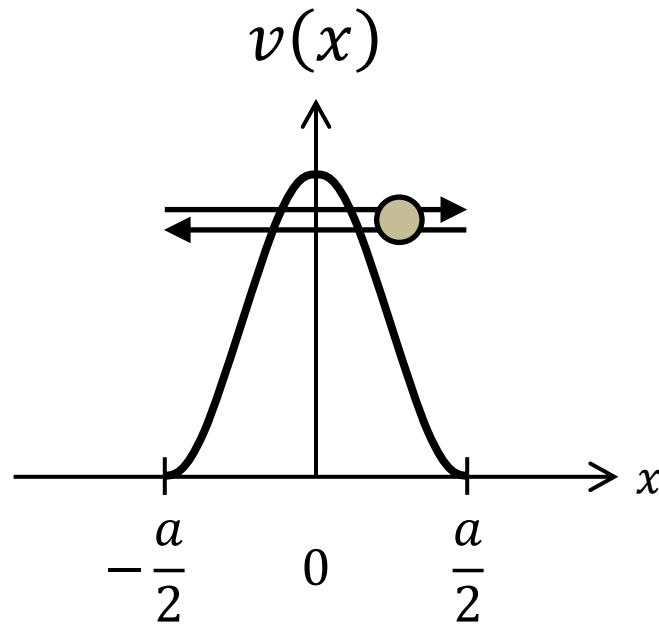

ポテンシャル領域(独立な解の重ね合わせ)

$$\psi(x) = A\psi_L + B\psi_R \quad -\frac{a}{2} \leq x \leq \frac{a}{2}$$

周期ポテンシャルへの入反射

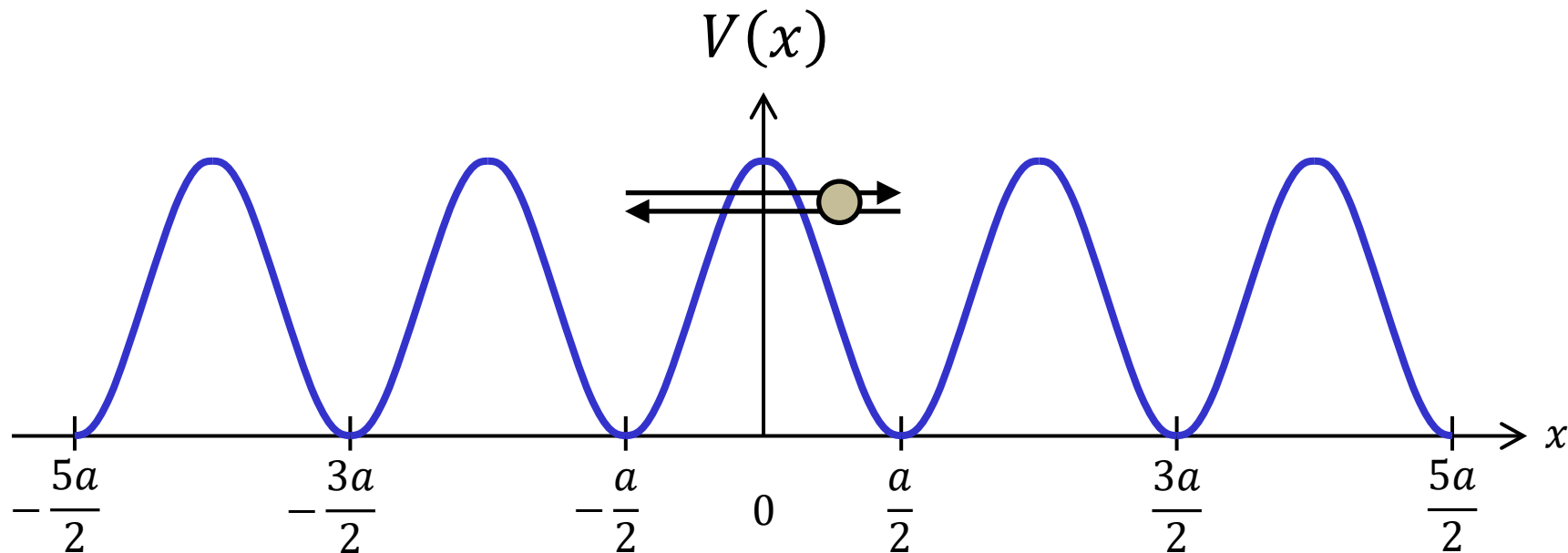

ポテンシャル領域(独立な解の重ね合わせ)

$$\psi(x) = A\psi_L + B\psi_R \quad -\frac{a}{2} \leq x \leq \frac{a}{2}$$

+ブロッホの定理

ブロッホの定理を適用

$$\psi(x + a) = e^{ika} \psi(x)$$

$$x = \frac{a}{2} \quad \psi(x) = Ate^{iKx} + B(e^{-iKx} + re^{iKx})$$

$$\psi\left(-\frac{a}{2} + a\right) = Ate^{iKa/2} + B(e^{-iKa/2} + re^{iKa/2})$$

$$x = -\frac{a}{2} \quad \psi(x) = A(e^{iKx} + re^{-iKx}) + Bte^{-iKx}$$

$$e^{ika} \psi\left(-\frac{a}{2}\right) = e^{ika} [A(e^{-iKa/2} + re^{iKa/2}) + Bte^{iKa/2}]$$

$$A(te^{iKa/2} - e^{ika} e^{-iKa/2} - re^{ika} e^{iKa/2})$$

$$= B(te^{ika} e^{iKa/2} - e^{-iKa/2} - re^{iKa/2})$$

ブロッホの定理を適用

$$\psi'(x+a) = e^{ika} \psi'(x)$$

$$x = \frac{a}{2} \quad \psi'(x) = iKAte^{iKx} - iKB(e^{-iKx} - re^{iKx})$$

$$\psi'\left(-\frac{a}{2} + a\right) = iKAte^{iKa/2} - iKB(e^{-iKa/2} - re^{iKa/2})$$

$$x = -\frac{a}{2} \quad \psi'(x) = iKA(e^{iKx} - re^{-iKx}) - iKBte^{-iKx}$$

$$e^{ika} \psi'\left(-\frac{a}{2}\right) = iKe^{ika} A(e^{-iKa/2} - re^{iKa/2}) - iKe^{ika} Bte^{iKa/2}$$

$$\begin{aligned} & A(te^{iKa/2} - e^{ika}e^{-iKa/2} + re^{ika}e^{iKa/2}) \\ & = B(-te^{ika}e^{iKa/2} + e^{-iKa/2} - re^{iKa/2}) \end{aligned}$$

振幅 A, B を消去

$$\frac{B}{A} = \frac{te^{iKa/2} - e^{ika}e^{-iKa/2} - re^{ika}e^{iKa/2}}{te^{ika}e^{iKa/2} - e^{-iKa/2} - re^{iKa/2}}$$

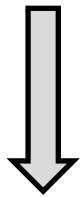

$$= \frac{te^{iKa/2} - e^{ika}e^{-iKa/2} + re^{ika}e^{iKa/2}}{-te^{ika}e^{iKa/2} + e^{-iKa/2} - re^{iKa/2}}$$

$$\begin{aligned}\cos ka &= \frac{t^2 - r^2}{2t} e^{iKa} + \frac{1}{2t} e^{-iKa} \\ &= \frac{e^{2i\delta}}{2|t|e^{i\delta}} e^{iKa} + \frac{1}{2|t|e^{i\delta}} e^{-iKa} \\ &= \frac{\cos(Ka + \delta)}{|t|}\end{aligned}$$

$$|t|^2 + |r|^2 = 1$$

$$t = |t|e^{i\delta}$$

$$r = i|r|e^{i\delta}$$

エネルギーギャップ

$$\cos ka = \frac{\cos(Ka + \delta)}{|t(K)|} = f(K) \quad E = \frac{\hbar^2 K^2}{2m}$$

一般に、 $|t| < 1$, δ は K に依存($K \rightarrow \infty, t \rightarrow 1$)

$|f(K)| < 1$ となる領域が許容帯となる(満たす k が存在)

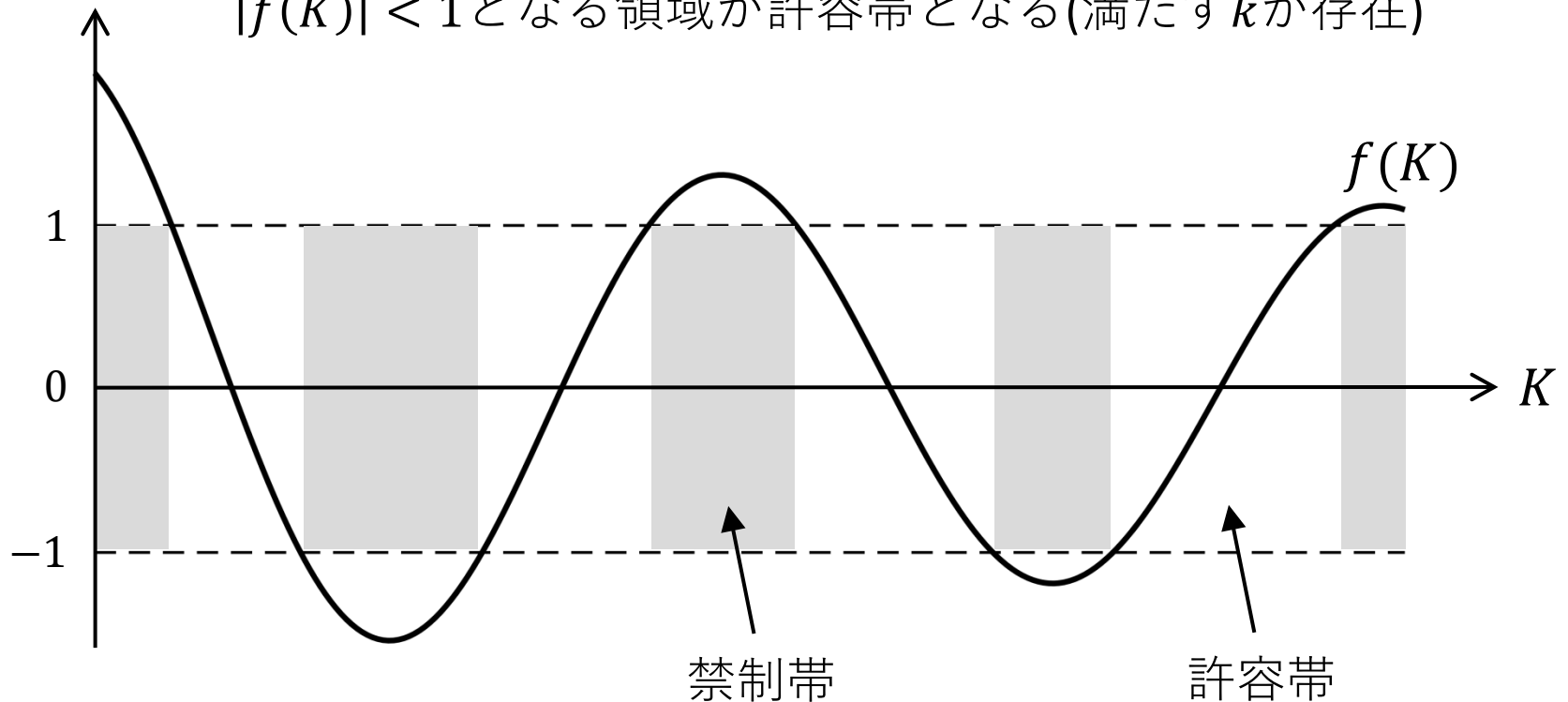

講義内容

- 半導体デバイスとノーベル賞
- 周期ポテンシャルとバンドギャップ
- **有効質量近似**

へテロ構造中の電子波動関数

有効質量近似 $\Psi(\mathbf{r}) = \chi(\mathbf{r})\psi(\mathbf{r})$

包絡関数

箱の中の粒子

ブロッホ関数

バルクの性質を反映

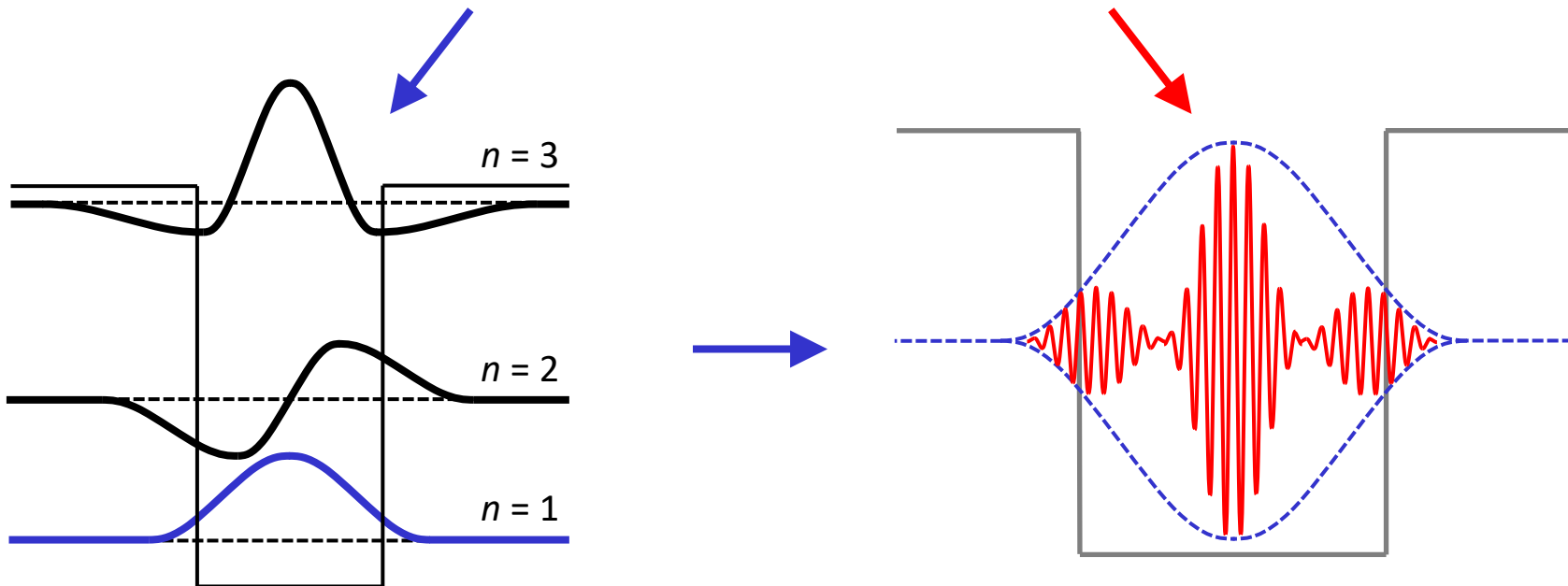

置換不純物

II (12)	III (13)	IV (14)	V (15)
	B	C	N
	Al	Si	P
Zn	Ga	Ge	As
Cd	In	Sn	Sb

ドナー

IV族: Si:P, Si:As, Ge:As...

III-V族: GaAs:Si

アクセプター

IV族: Si:B, Ge:Ga...

III-V族: GaAs:Zn

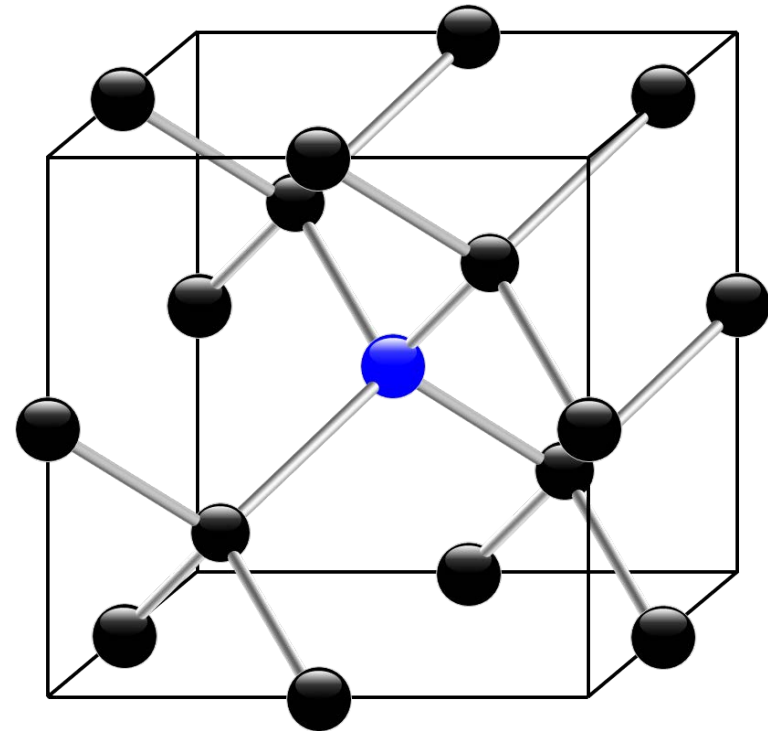

高温下

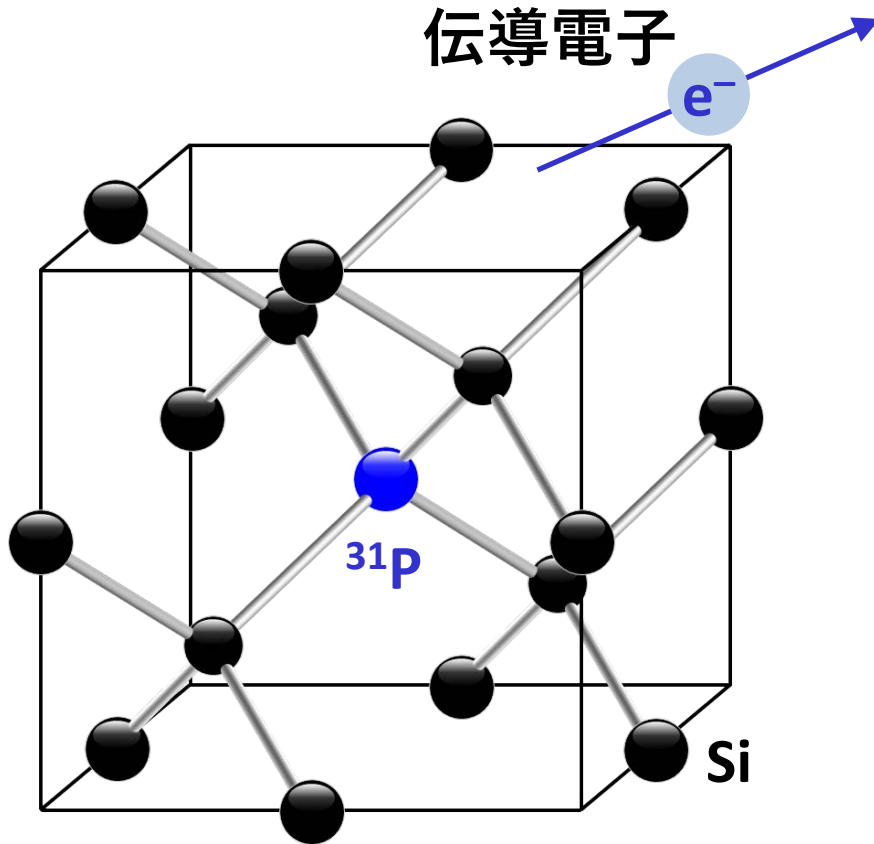

典型的な値

真性キャリア密度

$$n_i \approx 10^{10} \text{ cm}^{-3} \propto \exp\left(-\frac{E_g}{2k_B T}\right)$$

多数キャリア密度

$$n_d \approx N_D = 10^{16} \text{ cm}^{-3}$$

少数キャリア密度

$$n_p = \frac{n_i^2}{n_d} \approx \frac{n_i^2}{N_D} = 10^{14} \text{ cm}^{-3}$$

Siの場合、室温では100%イオン化

低温下

浅い不純物

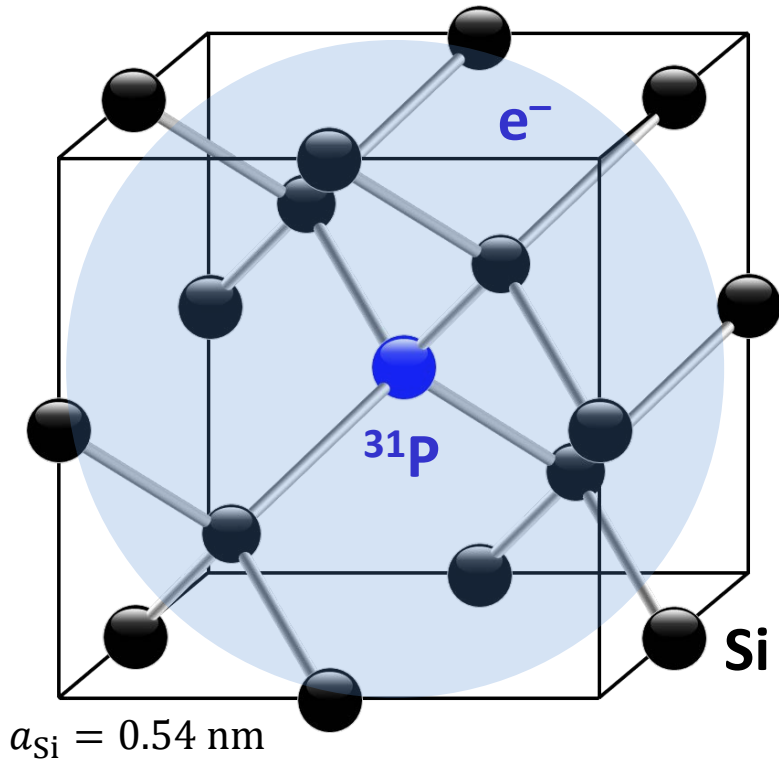

$$a_B^* = 3.2 \text{ nm}$$

真空中的水素原子

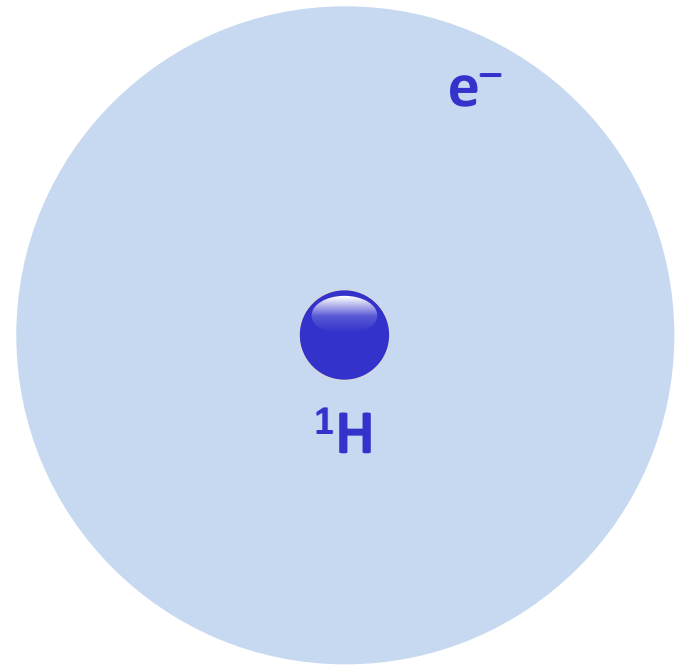

$$a_B = \frac{4\pi\epsilon_0\hbar^2}{me^2} = 0.053 \text{ nm}$$

Ultrapure silicon = “Semiconductor vacuum”

不純物準位の分光 n -Si

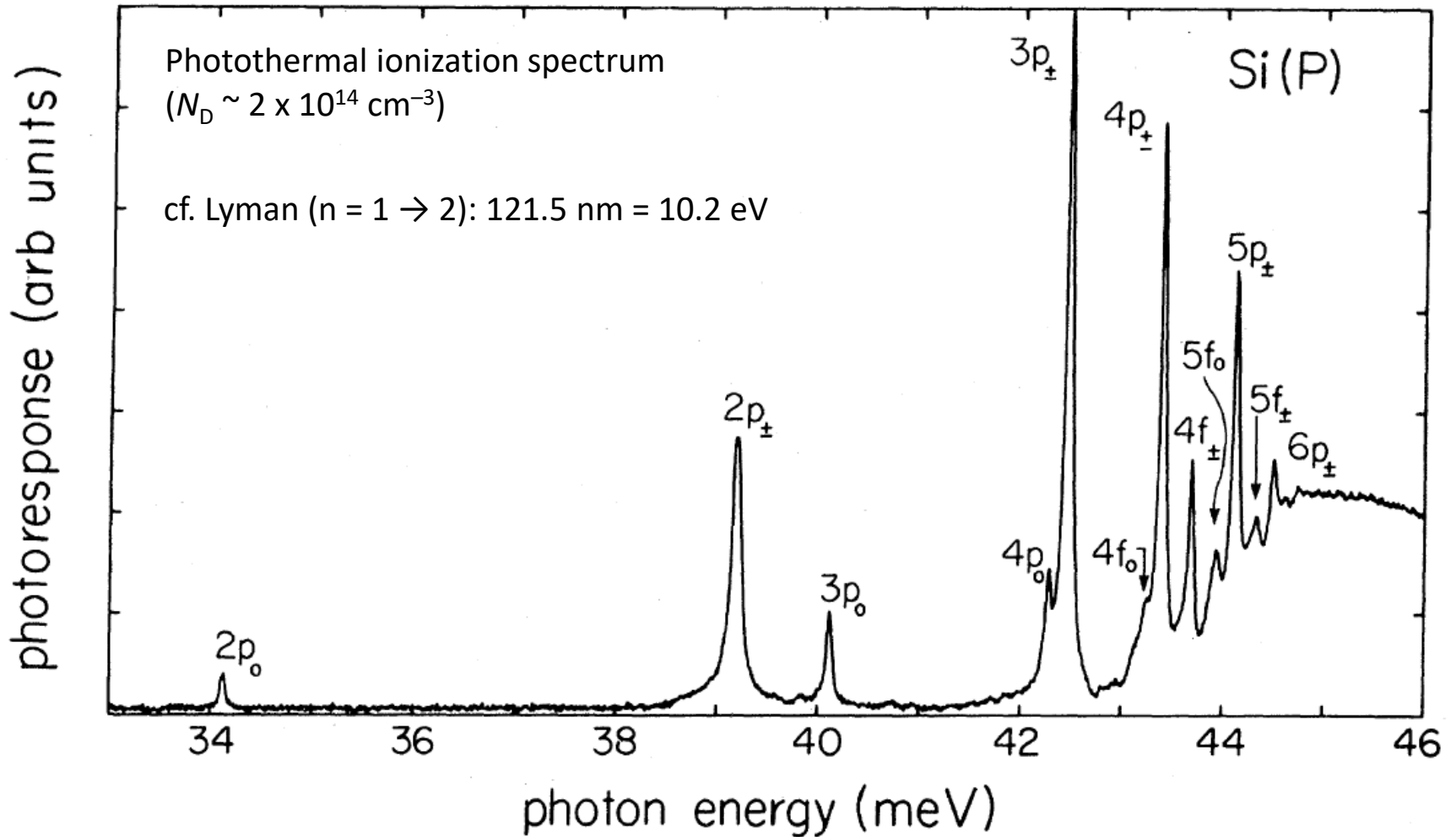

不純物準位の分光 n -GaAs

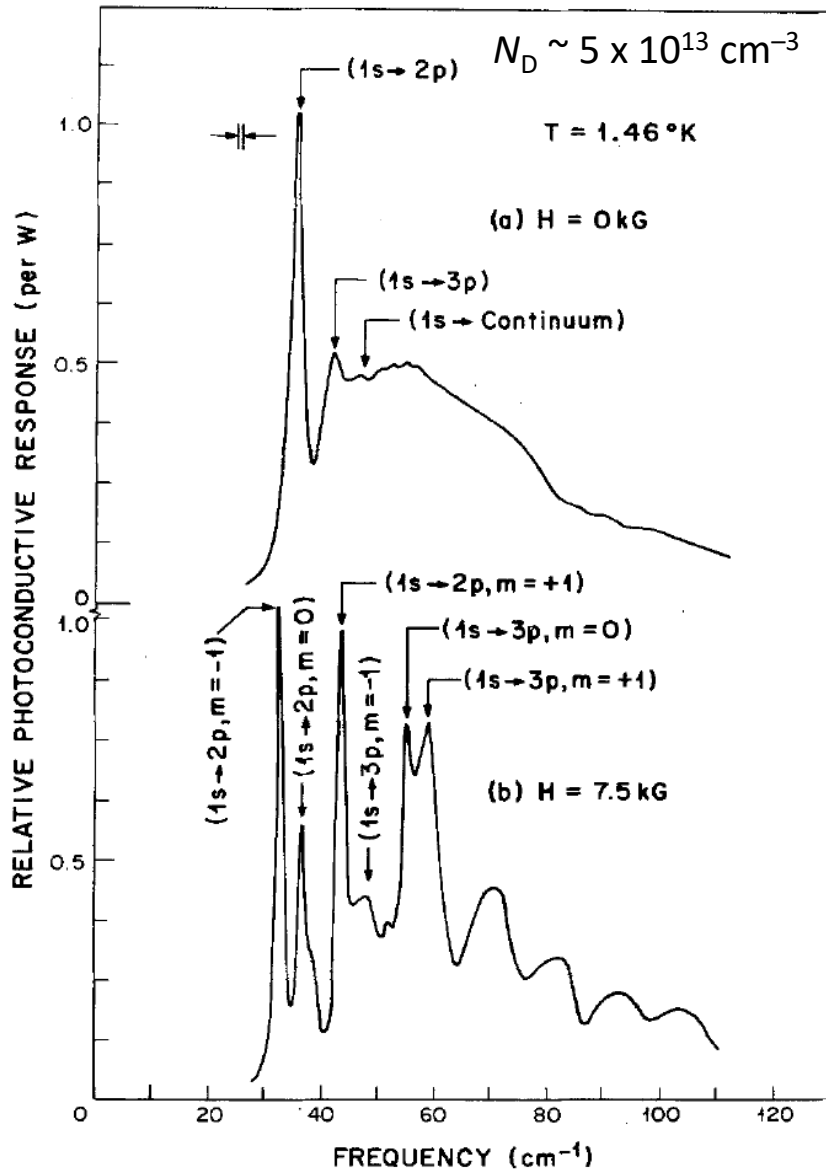

$35.5 \text{ cm}^{-1} = 4.4 \text{ meV}$

cf. Lyman ($n = 1 \rightarrow 2$): $121.5 \text{ nm} = 10.2 \text{ eV}$

エネルギースケールが3-4桁異なる
にも関わらず水素原子っぽい

シュレディンガー方程式

$$\left(-\frac{\hbar^2}{2m} \nabla^2 + \underbrace{V(\mathbf{r})}_{\text{格子周期のポテンシャル}} + \underbrace{U(\mathbf{r})}_{\text{不純物ポテンシャル(例えばクーロン)}} \right) \Psi(\mathbf{r}) = E_u \Psi(\mathbf{r})$$

格子周期のポテンシャル

結晶全体に広がっている

不純物ポテンシャル(例えばクーロン)

不純物周辺に局在
(格子周期よりは十分広がっている)

有効質量近似

$$\left(-\frac{\hbar^2}{2m^*} \nabla^2 + U(\mathbf{r}) \right) \chi(\mathbf{r}) = (E_u - E_c) \chi(\mathbf{r})$$

有効質量

包絡関数

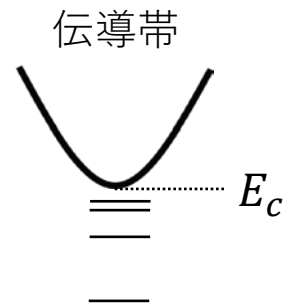

周期ポテンシャルの効果が有効質量に取り込まれた、
局在ポテンシャル下での式(有効質量方程式)

ワニア関数

ブロッホ関数のフーリエ変換(空間的に局在した状態の記述に向く)

$$a(\mathbf{r} - \mathbf{l}) = \frac{1}{\sqrt{N}} \sum_{\mathbf{k}} e^{-i\mathbf{k} \cdot \mathbf{l}} \psi_{\mathbf{k}}(\mathbf{r})$$

格子ベクトル

$$\psi_{\mathbf{k}}(\mathbf{r}) = e^{i\mathbf{k} \cdot \mathbf{r}} u_{\mathbf{k}}(\mathbf{r}) = \frac{1}{\sqrt{N}} \sum_{\mathbf{l}} e^{i\mathbf{k} \cdot \mathbf{l}} a(\mathbf{r} - \mathbf{l})$$

方針 シュレディンガー方程式

$$[H + U(\mathbf{r})]\Psi(\mathbf{r}) = E_u \Psi(\mathbf{r})$$

の解をワニア関数の重ね合わせで表現する(完全正規直交系)

$$\Psi(\mathbf{r}) = \frac{1}{\sqrt{N}} \sum_{\mathbf{l}} \chi(\mathbf{l}) a(\mathbf{r} - \mathbf{l})$$

(細かい注)浅い不純物における空間的な局在は、並進対称性を壊すものの、 k 空間でもほとんど局在しているとみなせる程度なので、ブロッホ関数で展開しても計算上の手間はあまり変わらない

各項について積分

$$H\Psi + U\Psi = E_u \Psi$$

$$\begin{aligned} \int a^*(\mathbf{r} - \mathbf{l}') E_u \Psi(\mathbf{r}) d\mathbf{r} &= \int a^*(\mathbf{r} - \mathbf{l}') E_u \frac{1}{\sqrt{N}} \sum_{\mathbf{l}} \chi(\mathbf{l}) a(\mathbf{r} - \mathbf{l}) d\mathbf{r} \\ &= \frac{1}{\sqrt{N}} E_u \sum_{\mathbf{l}} \chi(\mathbf{l}) \int a^*(\mathbf{r} - \mathbf{l}') a(\mathbf{r} - \mathbf{l}) d\mathbf{r} \\ &= \frac{1}{\sqrt{N}} E_u \sum_{\mathbf{l}} \chi(\mathbf{l}) \delta_{\mathbf{l}'\mathbf{l}} \\ &= \frac{1}{\sqrt{N}} E_u \chi(\mathbf{l}') \end{aligned}$$

各項について積分

$$H\Psi + U\Psi = E_u \Psi$$

$$\int a^*(\mathbf{r} - \mathbf{l}') U \Psi(\mathbf{r}) d\mathbf{r} = \frac{1}{\sqrt{N}} \sum_{\mathbf{l}} \chi(\mathbf{l}) \int a^*(\mathbf{r} - \mathbf{l}') U a(\mathbf{r} - \mathbf{l}) d\mathbf{r}$$

$$\approx \frac{1}{\sqrt{N}} \sum_{\mathbf{l}} \chi(\mathbf{l}) U \delta_{\mathbf{l}'\mathbf{l}}$$

U は格子周期に比べて十分
ゆっくり変化

$$= \frac{1}{\sqrt{N}} U(\mathbf{l}') \chi(\mathbf{l}')$$

各項について積分

$$H\Psi + U\Psi = E_u \Psi$$

$$\int a^*(\mathbf{r} - \mathbf{l}') H\Psi(\mathbf{r}) d\mathbf{r} = \frac{1}{\sqrt{N}} \sum_{\mathbf{l}} \chi(\mathbf{l}) \int a^*(\mathbf{r} - \mathbf{l}') H a(\mathbf{r} - \mathbf{l}) d\mathbf{r}$$

積分の中身 $H a(\mathbf{r} - \mathbf{l}) = \frac{1}{\sqrt{N}} \sum_{\mathbf{k}} e^{-i\mathbf{k}\cdot\mathbf{l}} H \psi_{\mathbf{k}}(\mathbf{r})$

$\psi_{\mathbf{k}}$ は H の固有関数
一旦復活させる

$$= \frac{1}{\sqrt{N}} \sum_{\mathbf{k}} e^{-i\mathbf{k}\cdot\mathbf{l}} \varepsilon(\mathbf{k}) \psi_{\mathbf{k}}(\mathbf{r})$$

H が消えたら用済み

$$= \frac{1}{\sqrt{N}} \sum_{\mathbf{k}} e^{-i\mathbf{k}\cdot\mathbf{l}} \varepsilon(\mathbf{k}) \frac{1}{\sqrt{N}} \sum_{\mathbf{l}''} e^{i\mathbf{k}\cdot\mathbf{l}''} a(\mathbf{r} - \mathbf{l}'')$$

$$= \frac{1}{N} \sum_{\mathbf{k}, \mathbf{l}''} e^{-i\mathbf{k}\cdot(\mathbf{l} - \mathbf{l}'')} \varepsilon(\mathbf{k}) a(\mathbf{r} - \mathbf{l}'')$$

各項について積分

$$H\Psi + U\Psi = E_u \Psi$$

$$\begin{aligned} \int a^*(\mathbf{r} - \mathbf{l}') H\Psi(\mathbf{r}) d\mathbf{r} &= \frac{1}{\sqrt{N}} \sum_{\mathbf{l}} \chi(\mathbf{l}) \int a^*(\mathbf{r} - \mathbf{l}') \frac{1}{N} \sum_{\mathbf{k}, \mathbf{l}''} e^{-i\mathbf{k} \cdot (\mathbf{l} - \mathbf{l}'')} \varepsilon(\mathbf{k}) a(\mathbf{r} - \mathbf{l}'') d\mathbf{r} \\ &= \frac{1}{\sqrt{N}} \sum_{\mathbf{l}} \chi(\mathbf{l}) \frac{1}{N} \sum_{\mathbf{k}} e^{-i\mathbf{k} \cdot (\mathbf{l} - \mathbf{l}')} \varepsilon(\mathbf{k}) \\ &= \frac{1}{N^{3/2}} \sum_{\mathbf{l}, \mathbf{k}} e^{-i\mathbf{k} \cdot \mathbf{l}} \varepsilon(\mathbf{k}) \chi(\mathbf{l}' + \mathbf{l}) \\ &\approx \frac{1}{N^{3/2}} \sum_{\mathbf{l}, \mathbf{k}} e^{-i(\mathbf{k} - \mathbf{k}') \cdot \mathbf{l}} \varepsilon(\mathbf{k}) \chi(\mathbf{l}') \\ &= \frac{1}{\sqrt{N}} \varepsilon(\mathbf{k}') \chi(\mathbf{l}') \end{aligned}$$

フーリエ変換2回
で元に戻る

$$\begin{aligned} \chi(\mathbf{l}' + \mathbf{l}) &\approx e^{\mathbf{l} \cdot \nabla} \chi(\mathbf{l}') \\ &\approx e^{i\mathbf{k}' \cdot \mathbf{l}} \chi(\mathbf{l}') \end{aligned}$$

$$-i\nabla \leftrightarrow \mathbf{k}$$

有効質量近似

$$\sqrt{N} \int a^*(\mathbf{r} - \mathbf{l}') H \Psi(\mathbf{r}) d\mathbf{r} = \varepsilon(\mathbf{k}') \chi(\mathbf{l}') \quad (H + U)\Psi = E_u \Psi$$

$$\sqrt{N} \int a^*(\mathbf{r} - \mathbf{l}') U \Psi(\mathbf{r}) d\mathbf{r} = U(\mathbf{l}') \chi(\mathbf{l}') \quad \varepsilon(\mathbf{k}) = E_c + \frac{\hbar^2 \mathbf{k}^2}{2m^*}$$

$$\sqrt{N} \int a^*(\mathbf{r} - \mathbf{l}') E_u \Psi(\mathbf{r}) d\mathbf{r} = E_u \chi(\mathbf{l}')$$

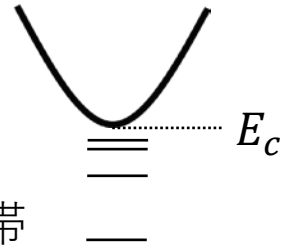

直接遷移型半導体の伝導帯
下端でのエネルギー分散

$$\begin{array}{c} \mathbf{l}' \rightarrow \mathbf{r} \\ \longrightarrow \end{array} \left(-\frac{\hbar^2}{2m^*} \nabla^2 + U(\mathbf{r}) \right) \chi(\mathbf{r}) = (E_u - E_c) \chi(\mathbf{r})$$

n-GaAsの浅い不純物をよく記述する

有効質量近似

$$\begin{aligned}\Psi(\mathbf{r}) &= \frac{1}{\sqrt{N}} \sum_{\mathbf{l}} \chi(\mathbf{l}) a(\mathbf{r} - \mathbf{l}) = \sum_{\mathbf{l}} \chi(\mathbf{l}) \frac{1}{N} \sum_{\mathbf{k}} e^{-i\mathbf{k} \cdot \mathbf{l}} \psi_{\mathbf{k}}(\mathbf{r}) \\ &= \sum_{\mathbf{l}} \chi(\mathbf{l}) \frac{1}{N} \sum_{\mathbf{k}} e^{-i\mathbf{k} \cdot (\mathbf{l} - \mathbf{r})} u_{\mathbf{k}}(\mathbf{r}) \approx u_0(\mathbf{r}) \sum_{\mathbf{l}} \chi(\mathbf{l}) \delta_{\mathbf{r}, \mathbf{l}} \\ &= u_0(\mathbf{r}) \chi(\mathbf{r})\end{aligned}$$

運動量空間で $\mathbf{k} \approx 0$ に局在

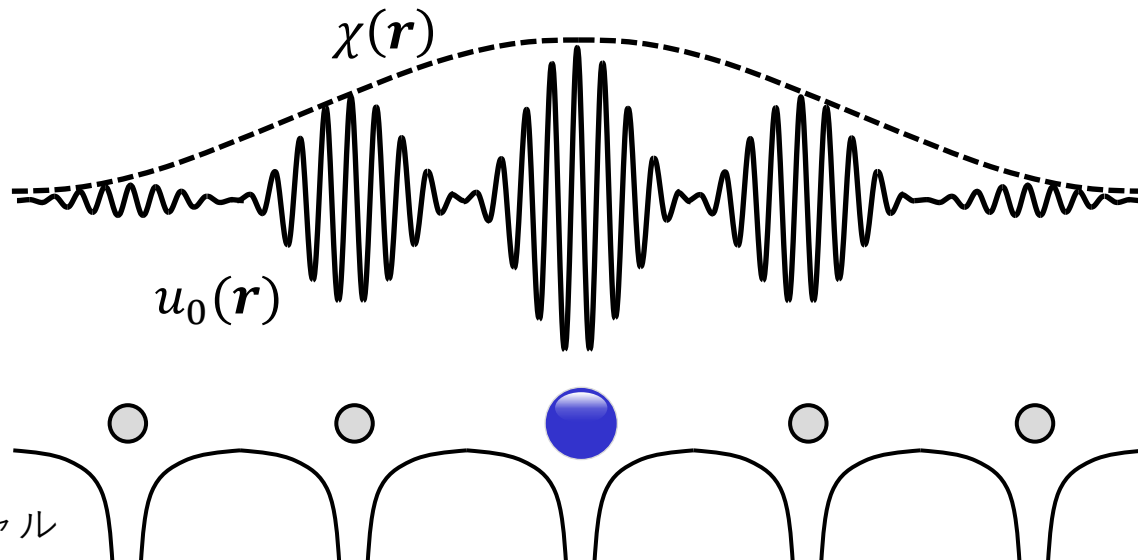

結晶ポテンシャル

有効質量近似

注意点

- 格子周期に対しゆるやかな変化が前提(ドナー近傍、ヘテロ界面?)
- 単一バンドのみ考慮(バンド間遷移は無視)
- 間接遷移半導体には、谷の縮退がある(谷-軌道相互作用、有効質量の異方性)
- アクセプター不純物では、価電子帯頂上の構造(重い正孔・軽い正孔)を考える必要があり、かなり複雑

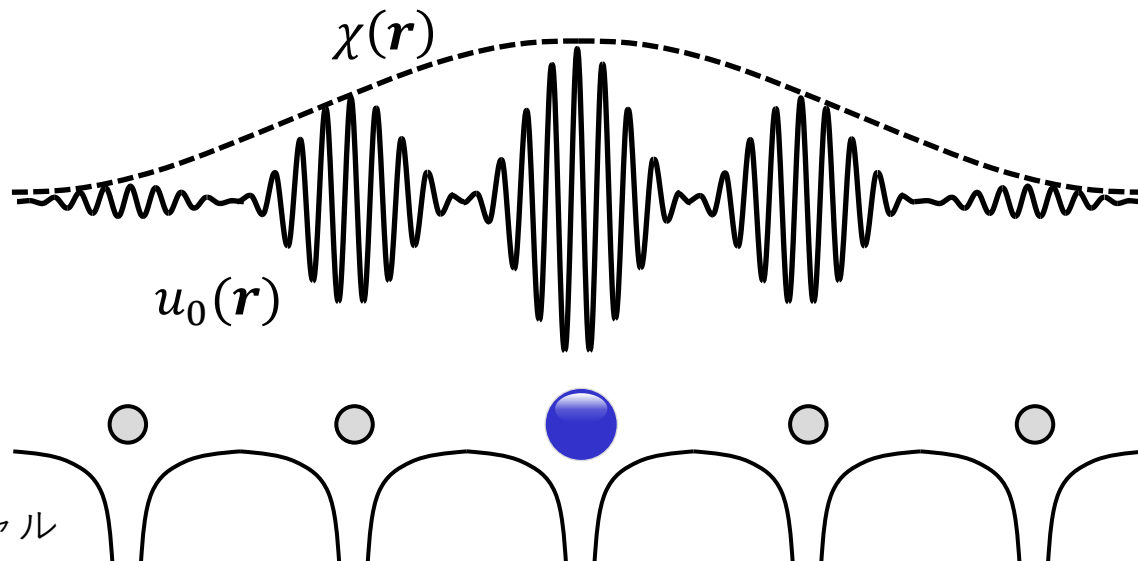

結晶ポテンシャル

最近の理論の進展

ドナー不純物を用いた量子情報処理の実験の進展に伴い、より正確な理論構築の必要性が増している(波動関数の空間分布の計算)

PHYSICAL REVIEW B **72**, 085202 (2005)

Donor electron wave functions for phosphorus in silicon: Beyond effective-mass theory

C. J. Wellard and L. C. L. Hollenberg

PHYSICAL REVIEW B **89**, 235306 (2014)

Exchange coupling between silicon donors: The crucial role of the central cell and mass anisotropy

G. Pica,^{1,*} B. W. Lovett,^{1,†} R. N. Bhatt,² and S. A. Lyon^{2,‡}

PHYSICAL REVIEW B **92**, 195302 (2015)

Multivalley envelope function equations and effective potentials for phosphorus impurity in silicon

M. V. Klymenko,¹ S. Rogge,² and F. Remacle^{1,*}

参考書

- **The Silicon Engine, Computer History Museum**
 - <http://www.computerhistory.org/siliconengine/>
- N. W. Ashcroft & N. D. Mermin (1976)
 - **“Solid State Physics”** (邦訳あり)
- J. H. Davies (1997)
 - **“The Physics of Low-Dimensional Semiconductors”** (邦訳あり)